



USER'S MANUAL

# Gocator 2000 Family

Version 3.0.3.1 Revision: C

Copyright © 2011 by LMI Technologies, Inc. All rights reserved.

### **Proprietary**

This document, submitted in confidence, contains proprietary information which shall not be reproduced or transferred to other documents or disclosed to others or used for manufacturing or any other purpose without prior written permission of LMI Technologies Inc.

No part of this publication may be copied, photocopied, reproduced, transmitted, transcribed, or reduced to any electronic medium or machine readable form without prior written consent of LMI Technologies, Inc.

### **Trademarks and Restrictions**

Gocator™ is a registered trademark of LMI Technologies, Inc. Any other company or product names mentioned herein may be trademarks of their respective owners.

Information contained within this manual is subject to change.

This product is designated for use solely as a component and as such it does not comply with the standards relating to laser products specified in U.S. FDA CFR Title 21 Part 1040.

### **Contact Information**

For more information, please contact LMI Technologies.

LMI Technologies, Inc.  
1673 Cliveden Ave.  
Delta, BC V3M 6V5  
Canada

Telephone: +1 604 636 1011  
Facsimile: +1 604 516 8368

[www.lmi3d.com](http://www.lmi3d.com)

# Introduction

The Gocator 2000 Family of laser profiling sensors are designed for 3D measurement and control applications. Gocator sensors are configured using a web browser and can be connected to a variety of input and output devices. This guide describes the installation and use of Gocator sensors.

## Notational Conventions

This guide uses the following notational conventions:

 Warning      Follow these safety guidelines to avoid potential injury or property damage.

 Note          Consider this information in order to make best use of the product.

# Table of Contents

Introduction	3	Profile and Raw Mode	41
Table of Contents	4	Whole Part	43
<hr/>			
<b>Safety and Maintenance</b>	<b>8</b>	Profile Output	45
Laser Safety	8	Coordinate Systems	45
Laser Classes	9	Resampled And Raw Profile Format	46
Precautions and Responsibilities	10	Intensity Output	47
Class 3B Responsibilities	10	Trigger	48
Systems Sold or Used in the USA	11	Examples	50
Electrical Safety	12	Settings	52
Environment and Lighting	13	Active Area	53
Sensor Maintenance	13	Exposure	54
<hr/>			
<b>Getting Started</b>	<b>14</b>	Single Exposure	55
System Overview	14	Dynamic Exposure	56
Standalone System	14	Multiple Exposures	57
Dual Sensor (Buddy) System	15	Resolutions	58
Multi-Sensor System	16	X Resolution	58
Hardware	17	Z Resolution	59
Sensor	17	Transformations	60
Master 200	18	Dual Sensor System Layout	61
Master 400/800	19	Overlap	62
Master 1200/2400	20	Calibration	63
Cordsets	21	Calibration States	63
Calibration Targets	22	Alignment vs. Travel Calibration	63
Installation	23	Alignment Calibration	64
Grounding - Standalone / Master 200	23	Travel Calibration	65
Grounding - Master 400/800/1200/2400	23	Clearing Calibration	66
Mounting	24	Filters	67
Orientations	25	X Resampling Interval	68
Software	27	Gap Filling	69
User Interface Overview	27	Smoothing	70
Connecting to a New Sensor	28	Part Detection	71
Running for the First Time	30	<hr/>	
Running a Standalone Sensor System	30	<b>Measurement</b>	<b>72</b>
Running a Dual Sensor System	32	Measurement Page	72
Next Steps	36	Adding and Removing Measurements	73
<hr/>			
<b>Setup and Calibration</b>	<b>37</b>	Changing the Measurement Name	74
Setup Page	37	Profile Sources	76
Operation Modes	39	Decisions	77
Data Viewer	40	Profile Fixturing	78
Video Mode	40	Script Measurement	80
<hr/>			
		Built-in Functions	80
<hr/>			
		<b>Profile Measurement Tools</b>	<b>82</b>
		Feature Points	85
		Fit Lines	87
		Measurement Types	88

Width	88
Height	89
Distance	90
Position X	91
Position Z	92
Center X	93
Center Z	94
Angle X	95
Intersect X	96
Intersect Z	97
Intersect Angle	98
Intersect Area	99
Box Area	100
Difference Area	101
Difference Peak	102
Script	103

---

## **Whole Part Measurement Tools 104**

Measurement Types	108
Area	108
Volume	109
Centroid X	110
Centroid Y	111
Centroid Z	112
Height	113
Ellipse Angle	114
Ellipse Minor	115
Ellipse Major	116
Ellipse Ratio	117
Bounding Box X	118
Bounding Box Y	119
Bounding Box Width	120
Bounding Box Length	121
Script	122

---

## **Output 123**

Output Page	123
Ethernet Control and Output	124
Digital Outputs	126
Analog Output	129

---

## **Toolbar 132**

Saving and Loading Settings	133
Managing Multiple Settings	135
Recording and Playback	136
Downloading, Exporting and Uploading	
Recorded Data	137

---

## **Dashboard 139**

Dashboard Page	139
State and Health Information	140
Metric Panel	141

---

## **Connection and Maintenance 142**

Connection Page	142
Network Settings	143
Auto Starting Sensors	144
Buddy Assignment	145
Security	146
File Management	147
Backup and Restore	148
Firmware Upgrade	149

---

## **Recovery 150**

Sensor Recovery Tool	150
----------------------	-----

---

## **Gocator Protocol 151**

Concepts	152
Discovery	152
Command Channels	152
Result Channels	152
Modes	153
Buddy Communication Channels	153
States	153
Versions and Upgrades	153
Data Types	154
Profile Sources	154
Status Codes	154
Command and Reply Formats	155
Result Format	156
Configuration Files	157
Setup	157
Profile	161
Part	168
Output	172
Calibration File	175
SysCal	176
Discovery Commands	177
Get Address	177
Set Address	178
Upgrade Commands	179
Get Protocol Version	179
Start Upgrade	179
Get Upgrade Status	179

Get Upgrade Log	180
Control Commands	181
Get Protocol Version	181
Get System Info	181
Log In/Out	182
Change Password	183
Change Buddy	183
Get File List	183
Copy File	184
Read File	184
Write File	184
Delete File	185
Get Default File	185
Set Default File	186
Get Loaded File	186
Get Mode	186
Set Mode	187
Get Time	187
Get Encoder	187
Start	188
Scheduled Start	188
Stop	188
Trigger	189
Scheduled Digital Output	189
Scheduled Analog Output	189
Ping	190
Reset	190
Backup	190
Restore	191
Restore Factory	191
Set Connection Type	192
Get Connection Type	192
Data Results	193
Video	193
Profile	193
Profile Intensity	194
Part Profile	194
Part Intensity	195
Alignment Calibration	195
Travel Calibration	195
Exposure Calibration	195
Measurement	196
Health Results	197

---

## **Modbus TCP Protocol 199**

Concepts	199
Messages	200
<b>Registers</b>	<b>202</b>
Control Registers	202
Output Registers	203
Measurement Registers	204

---

## **Serial Protocol 205**

Connection Settings	205
Message Format	206

---

## **Software Development Kit 208**

---

## **Troubleshooting 209**

Mechanical/Environmental	209
Connection	209
Laser Profiling	209
Performance	210

---

## **Specification 211**

Gocator sensors	211
Gocator 2020	213
Gocator 2030	215
Gocator 2040	217
Gocator 2050	219
Gocator 2070	221
Gocator 2080	223
Gocator I/O Connector	225
Grounding Shield	225
Power	225
Laser Safety Input	226
Digital Outputs	227
Digital Inputs	228
Encoder Input	228
Serial Output	229
Analog Output	229
Master 200	231
Master 400/800	233
Master 400/800 Electrical Specifications	234
Master 1200/2400	235
Master 1200/2400 Electrical Specifications	236

---

## **Parts and Accessories 237**

---

## **Warranty and Return Policy 239**

Warranty Policy	239
Return Policy	239

---

<b>Software Licenses</b>	<b>240</b>
--------------------------	------------

---

Support	244
---------	-----

---

# Safety and Maintenance

## Laser Safety

Gocator sensors contain semiconductor lasers that emit visible light and are designated as Class 2M, Class 3R, or Class 3B, depending on the chosen laser option.

Gocator sensors are referred to as *components*, indicating that they are sold only to qualified customers for incorporation into their own equipment. These sensors do not incorporate safety items that the customer may be required to provide in their own equipment (e.g. remote interlocks, key control. Refer to references for detail information). As such, these sensors do not fully comply with the standards relating to laser products specified in IEC 60825-1 and FDA CFR Title 21 Part 1040.

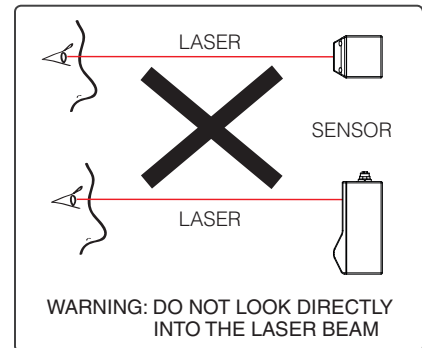

Use of controls or adjustments or performance of procedures other than those specified herein may result in hazardous radiation exposure.

### References

1. *International standard IEC 60825-1 (2001-08) consolidated edition*, Safety of laser products – Part 1: Equipment classification, requirements and user's guide.
2. *Technical report 60825-10*, Safety of laser products – Part 10. Application guidelines and explanatory notes to IEC 60825-1.
3. *Laser Notice No. 50*, FDA and CDRH <http://www.fda.gov/cdrh/rad-health.html>

## Laser Classes

### Class 2M laser components

Class 2M laser components would not cause permanent damage to the eye under reasonably foreseeable conditions of operation, provided that any exposure can be terminated by the blink reflex (assumed to take 0.25 seconds). Because classification assumes the blink reflex, the wavelength of light must be in the visible range (400 nm to 700 nm). The Maximum Permissible Exposure (MPE) for visible radiation for 0.25 seconds is 25 watts per square meter, which is equivalent to 1 mW entering an aperture of 7 mm diameter (the assumed size of the pupil).

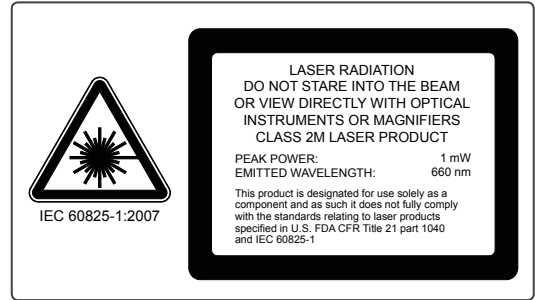

### Class 3R laser components

Class 3R laser products emit radiation where direct intrabeam viewing is potentially hazardous, but the risk is lower with 3R lasers than for 3B lasers. Fewer manufacturing requirements and control measures for 3R laser users apply than for 3B lasers.

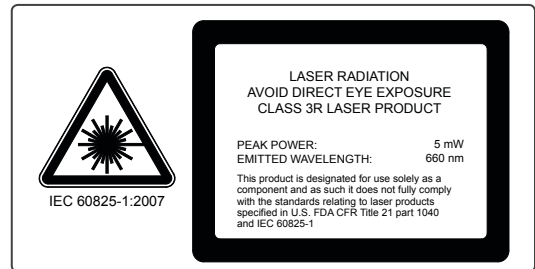

### Class 3B laser components

Class 3B components are unsafe for eye exposure. Usually only ocular protection will be required. Diffuse reflections are safe if viewed for less than 10 seconds.

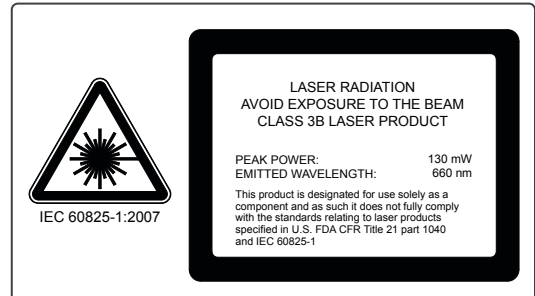

 Labels reprinted here are examples only. For accurate specifications, refer to the label on your sensor.

## Precautions and Responsibilities

Precautions specified in IEC 60825-1 and FDA CFR Title 21 Part 1040 are as follows:

Requirement	Class 2M	Class 3R	Class 3B
Remote interlock	Not required	Not required	Required*
Key control	Not required	Not required	Required – cannot remove key when in use*
Power-on delays	Not required	Not required	Required*
Beam attenuator	Not required	Not required	Required*
Emission indicator	Not required	Not required	Required*
Warning signs	Not required	Not required	Required*
Beam path	Not required	Terminate beam at useful length	Terminate beam at useful length
Specular reflection	Not required	Prevent unintentional reflections	Prevent unintentional reflections
Eye protection	Not required	Not required	Required under special conditions
Laser safety officer	Not required	Not required	Required
Training	Not required	Required for operator and maintenance personnel	Required for operator and maintenance personnel

*\*LMI Class 3B laser components do not incorporate these laser safety items. These items must be added and completed by the customer in their system design.*

## Class 3B Responsibilities

LMI Technologies has filed reports with the FDA to assist customers in achieving certification of laser products. These reports can be referenced by an accession number, provided upon request. Detailed descriptions of the safety items that must be added to the system design are listed below.

### Remote Interlock

A remote interlock connection must be present in Class 3B laser systems. This permits remote switches to be attached in serial with the keylock switch on the controls. The deactivation of any remote switches must prevent power from being supplied to any lasers.

### Key Control

A key operated master control to the lasers is required that prevents any power from being supplied to the lasers while in the OFF position. The key can be removed in the OFF position but the switch must not allow the key to be removed from the lock while in the ON position.

### Power-On Delays

A delay circuit is required that illuminates warning indicators for a short period of time prior to supplying power to the lasers.

### Beam Attenuators

A permanently attached method of preventing human access to laser radiation other than switches, power connectors or key control must be employed. On some LMI laser sensors, the beam attenuator is supplied with the sensor as an integrated mechanical shutter.

### Emission Indicator

It is required that the controls that operate the sensors incorporate a visible or audible indicator when power is applied and the lasers are operating. If the distance between the sensor and controls is more than 2 meters, or mounting of sensors intervenes with observation of these indicators, then a second

power-on indicator should be mounted at some readily-observable position. When mounting the warning indicators, it is important not to mount them in a location that would require human exposure to the laser emissions. User must ensure that the emission indicator, if supplied by OEM, is visible when viewed through protective eyewear.

### Warning Signs

Laser warning signs must be located in the vicinity of the sensor such that they will be readily observed. Examples of laser warning signs are as follows:

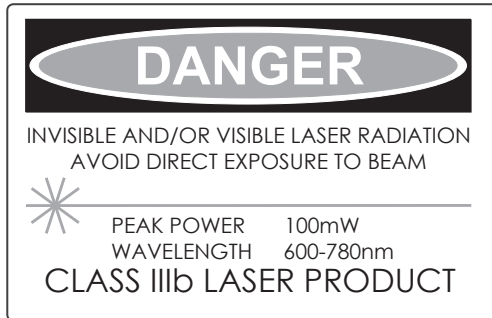

*FDA warning sign example*



*IEC warning sign example*

## Systems Sold or Used in the USA

Systems that incorporate laser components or laser products manufactured by LMI Technologies require certification by the FDA.

Customers are responsible for achieving and maintaining this certification.

Customers are advised to obtain the information booklet *Regulations for the Administration and Enforcement of the Radiation Control for Health and Safety Act of 1968: HHS Publication FDA 88-8035*.

This publication, containing the full details of laser safety requirements, can be obtained directly from the FDA, or downloaded from their web site at <http://www.fda.gov/cdrh>.

# Electrical Safety

## **Sensors should be connected to earth ground**

All sensors should be connected to earth ground through their housing. All sensors should be mounted on an earth grounded frame using electrically conductive hardware to ensure the housing of the sensor is connected to earth ground. Use a multi-meter to check the continuity between the sensor connector and earth ground to ensure a proper connection.

## **Minimize voltage potential between system ground and sensor ground**

Care should be taken to minimize the voltage potential between system ground (ground reference for I/O signals) and sensor ground. This voltage potential can be determined by measuring the voltage between *Analog\_out-* and *system ground*. The maximum permissible voltage potential is 12 V but should be kept below 10 V to avoid damage to the serial and encoder connections. Refer to Gocator I/O Connector (page 225) for a description of connector pins.

## **Use a suitable power supply**

The +24 to +48 VDC power supply used with Gocator sensors should be an isolated supply with inrush current protection or be able to handle a high capacitive load.

## **Use care when handling powered devices**

Wires connecting to the sensor should not be handled while the sensor is powered. Doing so may cause electrical shock to the user or damage to the equipment.



Failure to adhere to the guidelines described in this section may result in electrical shock or equipment damage.

# Environment and Lighting

## **Avoid strong ambient light sources**

The imager used in this product is highly sensitive to ambient light hence stray light may have adverse effects on measurement. Do not operate this device near windows or lighting fixtures that could influence measurement. If the unit must be installed in an environment with high ambient light levels, a lighting shield or similar device may need to be installed to prevent light from affecting measurement.

## **Avoid installing sensors in hazardous environments**

To ensure reliable operation and to prevent damage to Gocator sensors, avoid installing the sensor in locations;

- that are humid, dusty, or poorly ventilated
- with a high temperature, such as places exposed to direct sunlight
- where there are flammable or corrosive gases
- where the unit may be directly subjected to harsh vibration or impact
- where water, oil, or chemicals may splash onto the unit
- where static electricity is easily generated

## **Ensure that ambient conditions are within specifications**

Gocator sensors are suitable for operation between 0 – 50 °C and 25 – 85% relative humidity (non-condensing). Measurement error due to temperature is limited to 0.015% of full scale per degree C.

The Master 200/400/800/1200/2400 is similarly rated for operation between 0 – 50 °C.

The storage temperature is -30 – 70 °C.

# Sensor Maintenance

## **Keep sensor windows clean**

Gocator sensors are high-precision optical instruments. To ensure the highest accuracy is achieved in all measurements, the windows on the front of the sensor should be kept clean and clear of debris.

## **Use care when cleaning sensor windows**

Use dry, clean air to remove dust or other dirt particles. If dirt remains, clean the windows carefully with a soft, lint-free cloth and non-streaking glass cleaner or isopropyl alcohol. Ensure that no residue is left on the windows after cleaning.

## **Turn off lasers when not in use**

LMI Technologies uses semiconductor lasers in 3D measurement sensors. To maximize the lifespan of the sensor, turn off the laser when not in use.

## **Avoid excessive modifications to files stored on the sensor**

Settings for Gocator sensors are stored in flash memory inside the sensor. Flash memory has an expected lifetime of 100,000 writes. To maximize lifetime, avoid frequent or unnecessary file save operations.

# Getting Started

## System Overview

Gocator sensors can be installed and used in a variety of scenarios. Sensors can be connected as standalone devices, or connected to a Master 200 for synchronized dual sensor (Main and Buddy) operation, or through a Master 400, 800, 1200, or 2400 for multi-sensor operation.

### Standalone System

Standalone systems are typically used when only a single Gocator sensor is required. The sensor can be connected to a computer's Ethernet port for setup and can also be connected to devices such as encoders, photocells, or PLCs.

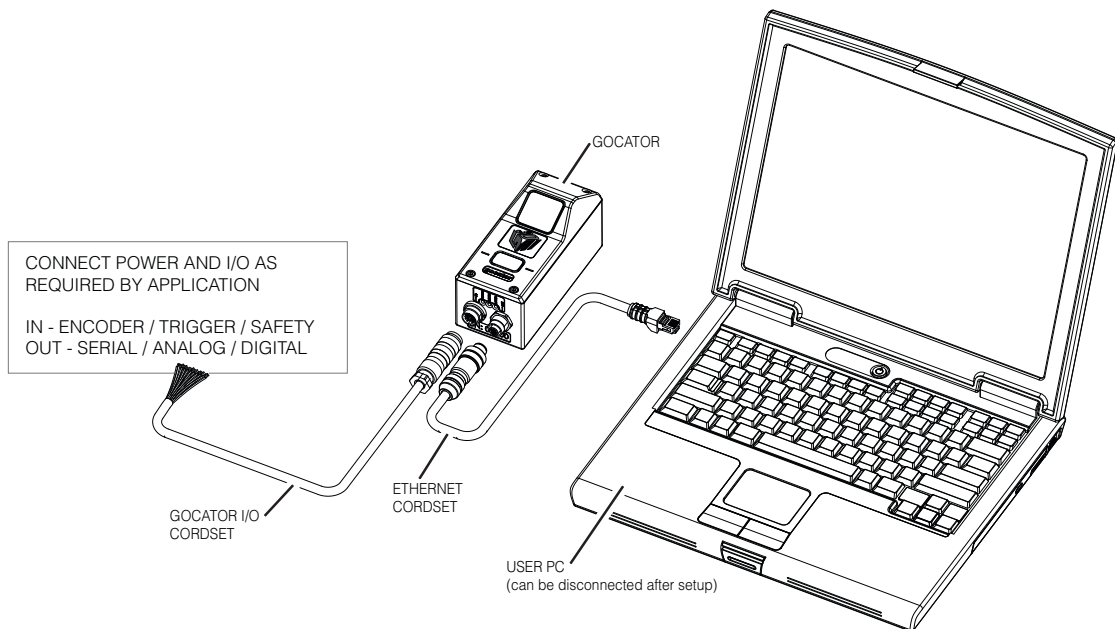

## Dual Sensor (Buddy) System

In a dual sensor system, two Gocator sensors work together to perform profiling and output the combined results. The controlling sensor is referred to as the Main sensor, and the helper is referred to as the Buddy sensor. Gocator's software recognizes three installation orientations – None, Opposite and Wide.

The Master 200 can be used to connect one or two sensors in a Dual Sensor (Buddy) system. Gocator I/O cordsets are used to connect sensors to the Master 200. The Master 200 provides a single point of connection for system I/O and power. The Master 200 can be used to ensure that the scan timing is precisely synchronized across sensors. Sensors and client computers typically communicate via an Ethernet switch (minimum 100 Mbit/s).

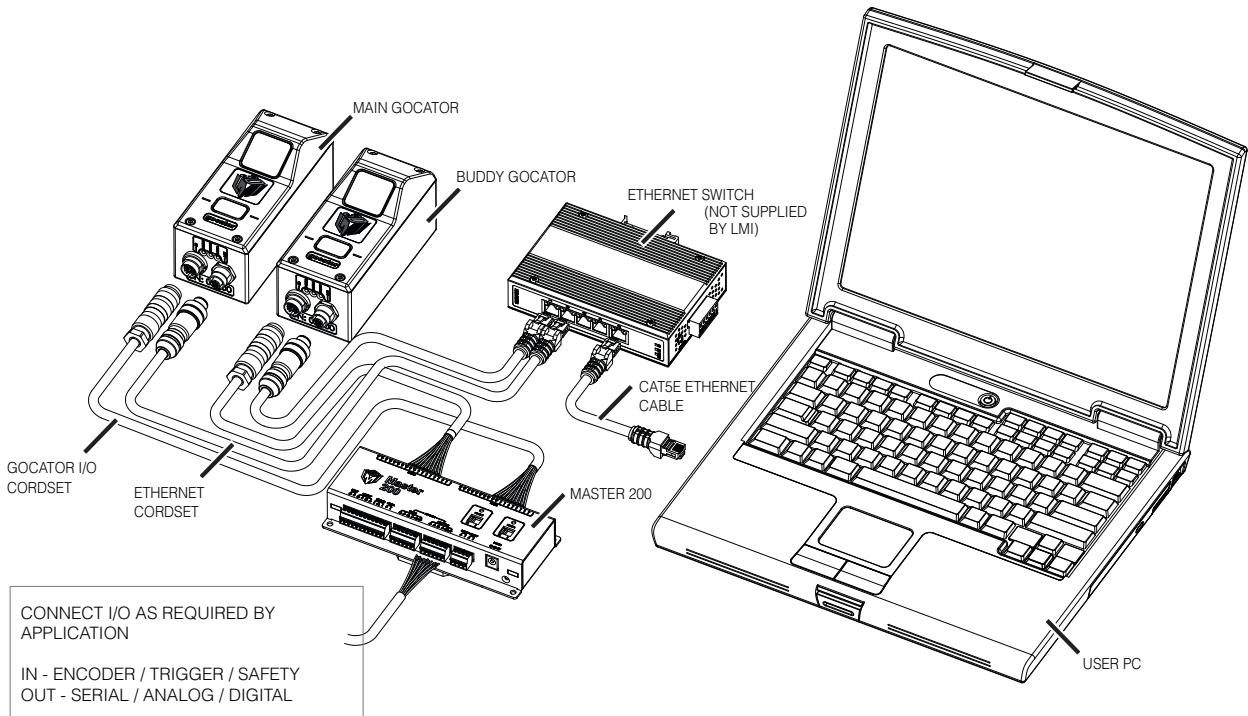

## Multi-Sensor System

Master 400/800/1200/2400 networking hardware can be used to connect two or more sensors into a Multi-sensor system. Gocator Master cordsets are used to connect the sensors to a Master. The Master provides a single point of connection for power, safety, encoder and digital inputs. A Master 400/800/1200/2400 can be used to ensure that the scan timing is precisely synchronized across sensors. Sensors and client computers communicate via an Ethernet switch (minimum 100 Mbit/s). Unlike the Master 200, Master 400/800/1200/2400 does not support digital, serial or analog output.

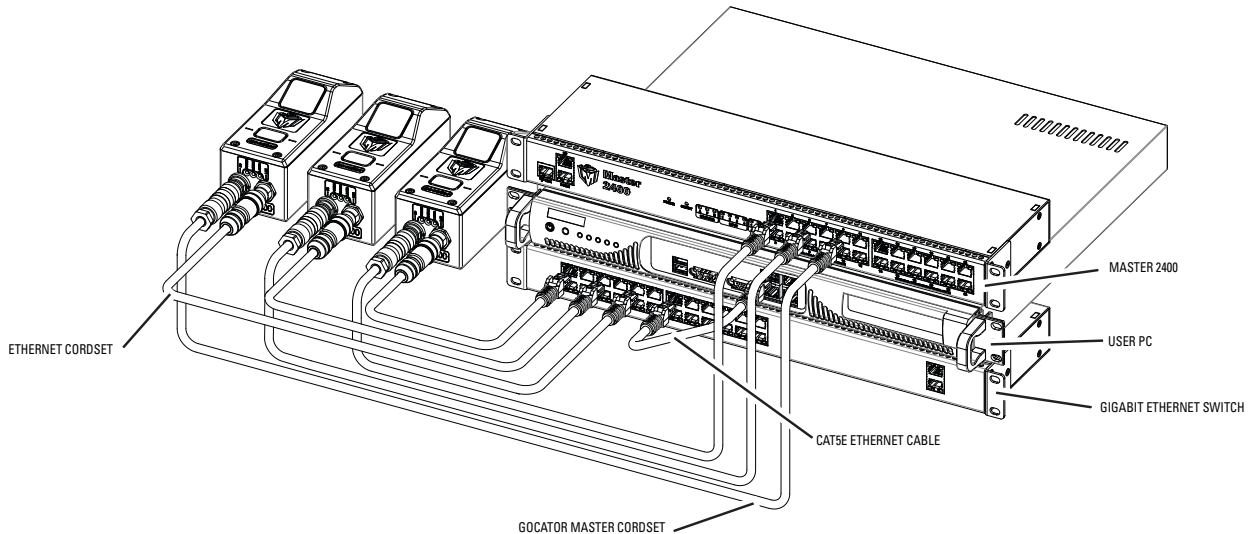

# Hardware

## Sensor

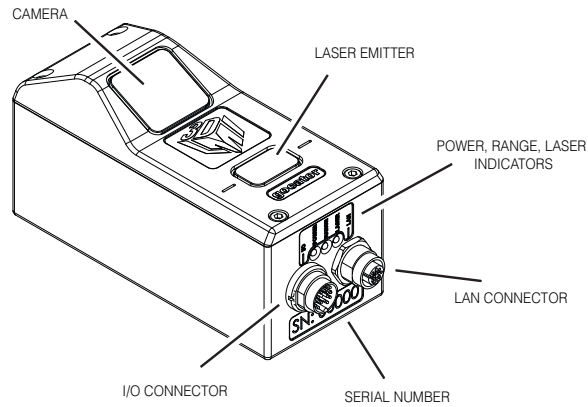

Item	Description
Camera	Observes laser light reflected from target surfaces.
Laser Emitter	Emits structured light for laser profiling.
I/O Connector	Accepts power and input/output signals.
LAN Connector	Connects to 100 Mbit/s Ethernet network.
Power Indicator	Illuminates when power is applied (blue).
Range Indicator	Illuminates when camera detects laser light and is within the target range (green).
Laser Indicator	Illuminates when laser safety input is active (amber).
Serial Number	Unique sensor serial number.

## Master 200

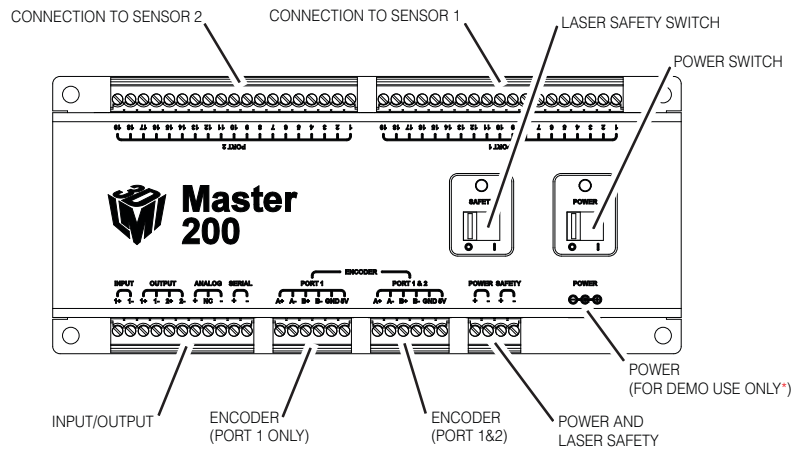

Item	Description
Connection to Sensor 2	Gocator I/O connection for Sensor 2 (Buddy sensor).
Connection to Sensor 1	Gocator I/O connection for Sensor 1 (Main sensor).
Laser Safety Switch	Toggles laser safety signal provided to the sensors [O= laser off, I= laser on].
Power Switch	Toggles sensor power.
Input/Output	Accepts digital input and provides digital output, serial output, and analog output.
Encoder (Port 1 only)	Accepts encoder for Standalone sensor operation (Main sensor only).
Encoder (Port 1 & 2)	Accepts encoder for Dual Sensor operation (Main and Buddy sensors).
Power and Laser Safety	Accepts power (+24 to +48 V at 10 Watts) and laser safety inputs.

Refer to Master 200 (page 231) for pinout details.

# Master 400/800

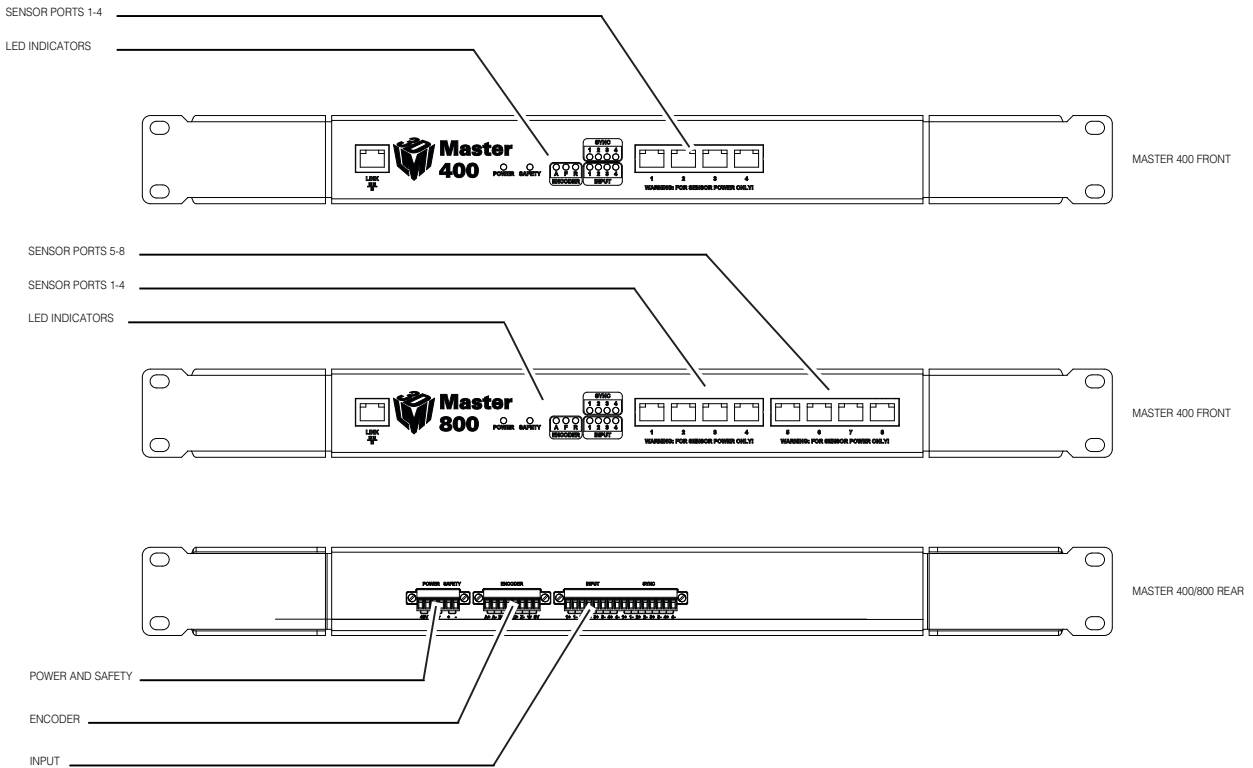

Item	Description
Sensor Ports	Master connection for Gocator sensors (no specific order required).
Ground Connection	Earth ground connection point.
Laser Safety	Laser safety connection.
Encoder	Accepts encoder signal.
Input	Accepts digital input.

Refer to Master 400/800 (page 233) for pinout details.

# Master 1200/2400

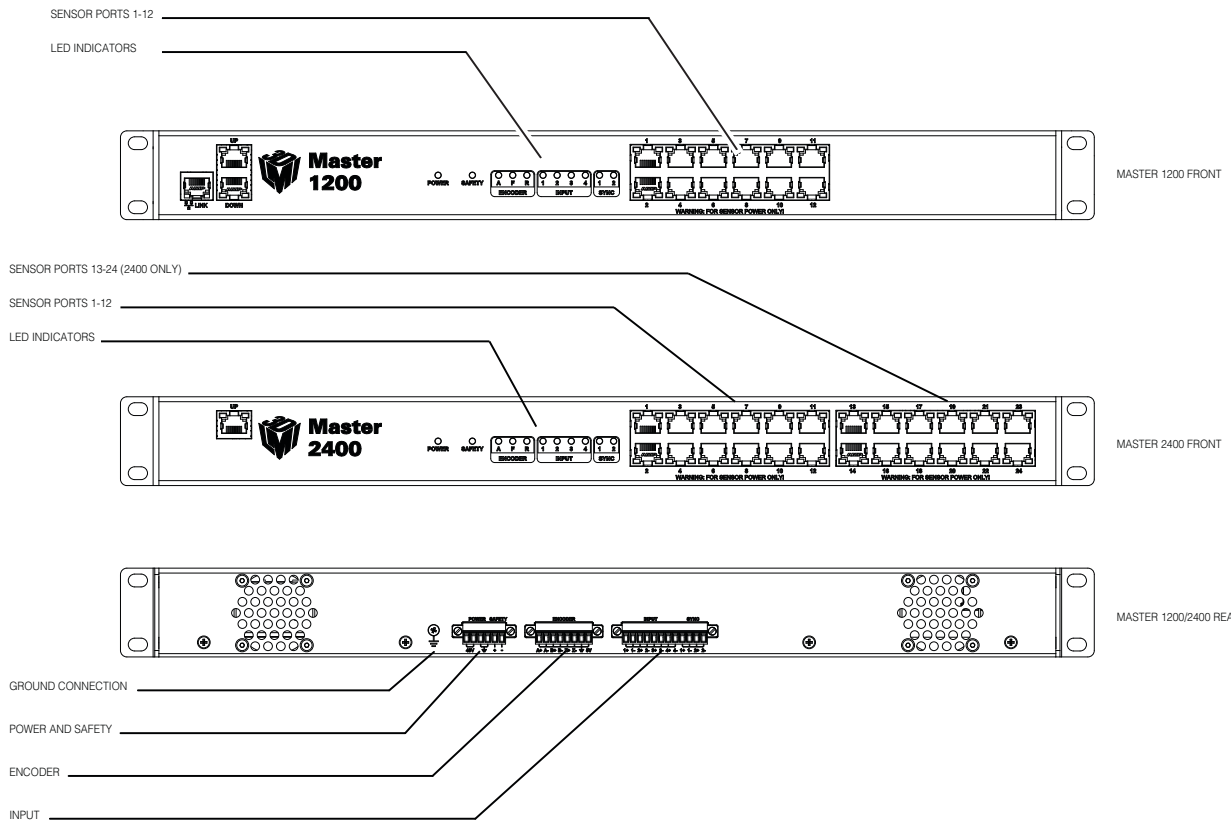

Item	Description
Sensor Ports	Master connection for Gocator sensors (no specific order required).
Ground Connection	Earth ground connection point.
Laser Safety	Laser safety connection.
Encoder	Accepts encoder signal.
Input	Accepts digital input.

Refer to Master 1200/2400 (page 235) for pinout details.

## Cordsets

Gocator sensors use three cordsets. The Ethernet cordset is used for sensor communication via 100 Mbit/s Ethernet with a standard RJ45 connector. The Gocator I/O cordset provides power and laser safety interlock to sensors, as well as digital I/O connections, an encoder interface, RS-485 serial connection, and an analog output. The Gocator Master cordset provides electrical connection between the sensor and a Master 400/800/1200/2400.

CORDSET, GOCATOR, ETHERNET, Xm

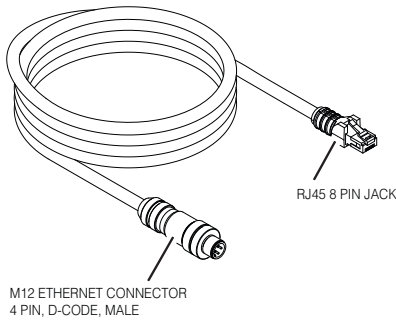

CORDSET, GOCATOR, POWER/I/O, Xm

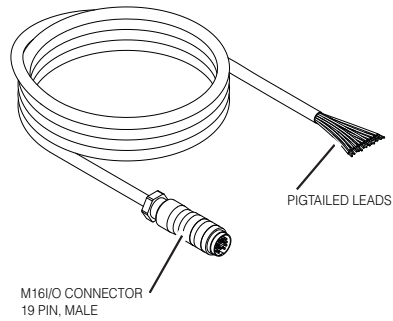

CORDSET, GOCATOR, MASTER, Xm

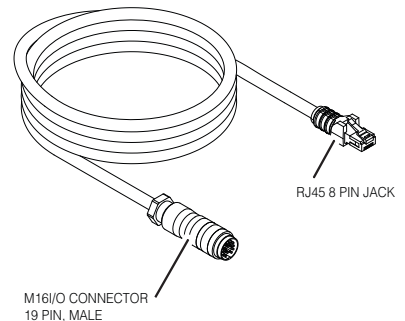

Refer to Gocator I/O Connector (page 225) for pinout details. Refer to Parts and Accessories (page 237) for cordset lengths and part numbers.

## Calibration Targets

Calibration targets are used for *alignment calibration* or *travel calibration*.

Calibration *disks* are typically used with systems containing a single sensor and can be ordered from LMI Technologies. When choosing a disk for your application, select the largest disk that fits entirely within the required field of view. Refer to Parts and Accessories (page 237) for calibration disk part numbers.

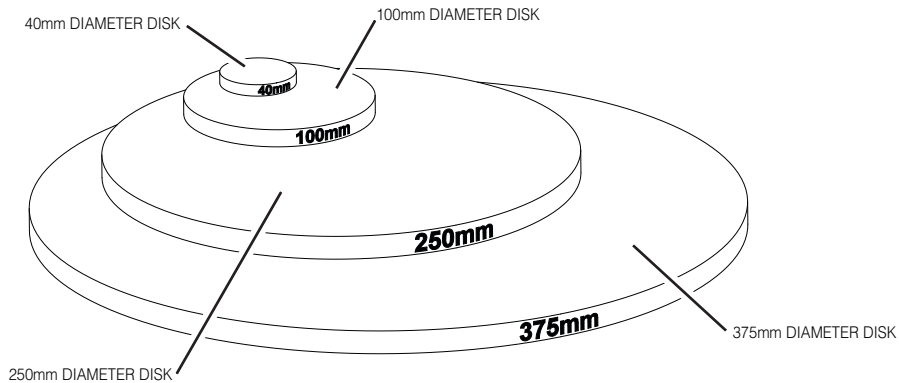

For wide, multi-sensor systems, calibration *bars* are required to match the length of the system by following the guidelines illustrated below. (LMI Technologies does not manufacture or sell calibration bars.)

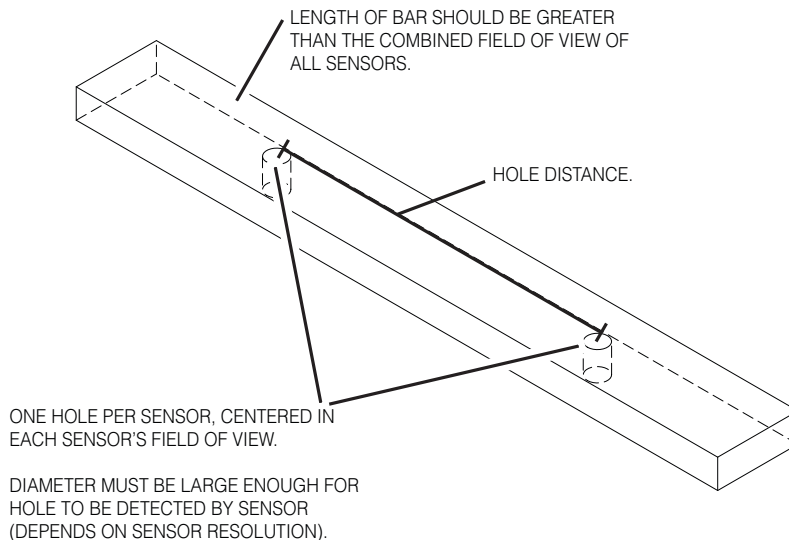

Refer to Calibration (page 63) for more information on calibration procedures.

# Installation

## Grounding - Standalone / Master 200

Gocators should be grounded to the earth/chassis through their housings and through the grounding shield of the Power I/O cordset. Gocator sensors have been designed to provide adequate grounding through the use of M5 x 0.8 pitch mounting screws. Always check grounding with a multi-meter to ensure electrical continuity between the mounting frame and the Gocator's connectors.



It is imperative that the frame or electrical cabinet that the Gocator is mounted to is connected to earth ground.

## Grounding - Master 400/800/1200/2400

The mounting brackets of all Masters have been designed to provide adequate grounding through the use of star washers. Always check grounding with a multi-meter by ensuring electrical continuity between the mounting frame and RJ45 connectors on the front.



It is imperative that the frame or electrical cabinet that the Master is mounted to is connected to earth ground.

## Mounting

Sensors should be mounted using four M5 x 0.8 pitch screws of suitable length. The recommended thread engagement into the housing is 8 - 10 mm. Proper care should be taken in order to ensure that the internal threads are not damaged from cross-threading or improper insertion of screws.

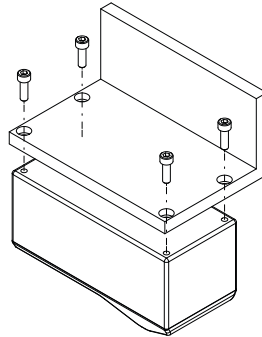

Sensors should not be installed near objects that might occlude a camera's view of the laser.

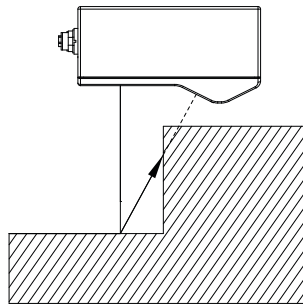

Sensors should not be installed near surfaces that might create unanticipated laser reflections.

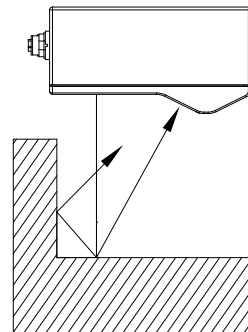
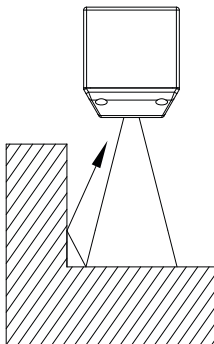

## Orientations

The examples below illustrate the possible mounting orientations for standalone and dual sensor system. For more information on orientations, refer to Dual Sensor System Layout (page 61).

### Single Sensor Orientations:

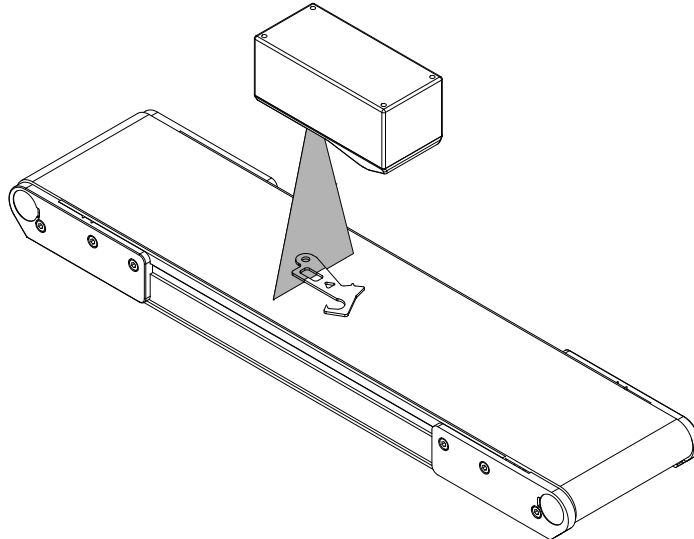

*Single sensor above conveyor*

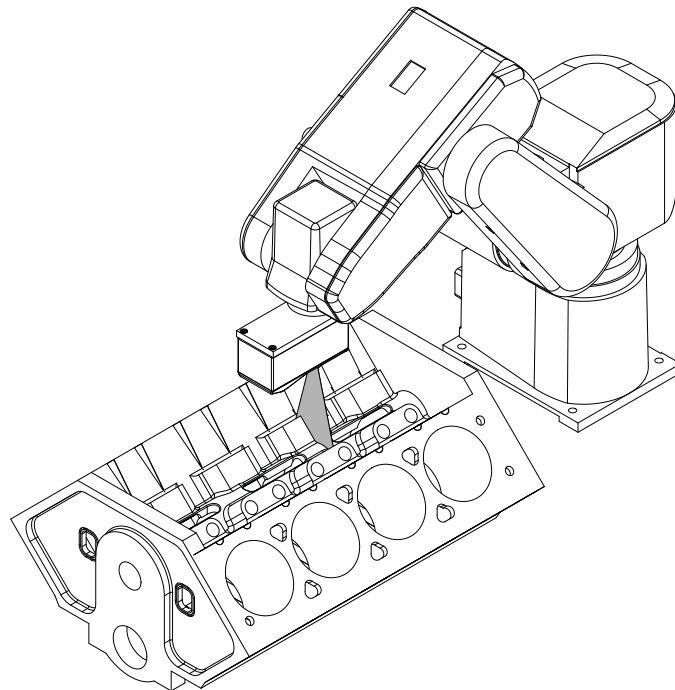

*Single sensor on robot arm*

**Dual Sensor System Orientations:**

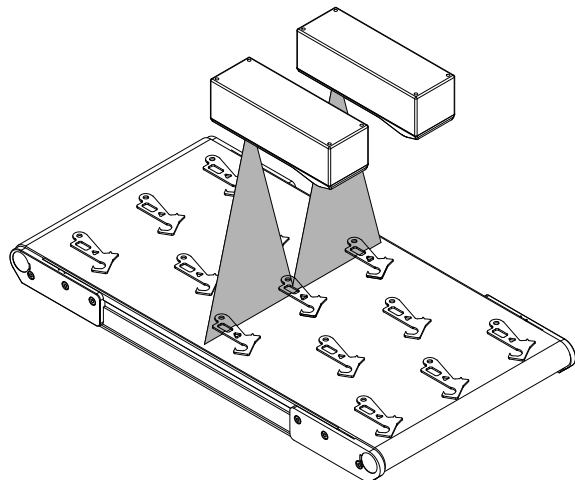

*Side-by-side for wide-area measurement (Wide)*

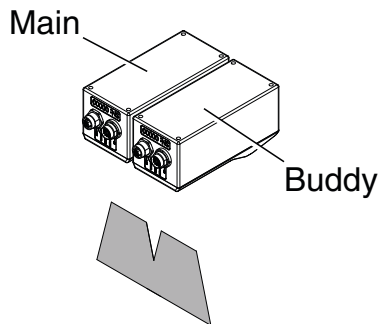

*Main must be on the left side (when looking into the connector) of the Buddy (Wide)*

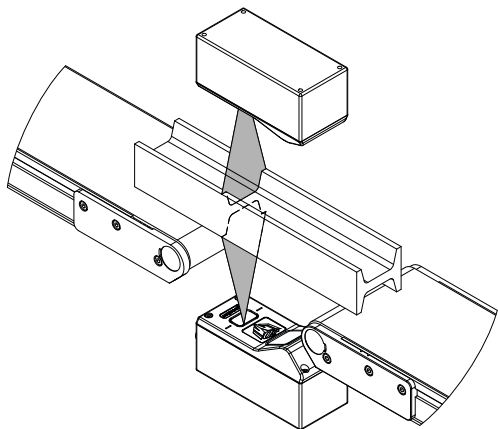

*Above/below for two-sided measurement (Opposite)*

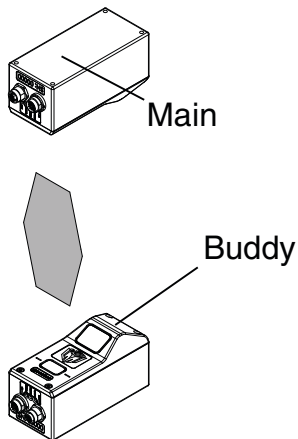

*Main must be on the top with Buddy on the bottom (Opposite)*

# Software

## User Interface Overview

Gocator sensors are configured by connecting to a *Main* sensor with a web browser. The Gocator web interface is illustrated below.

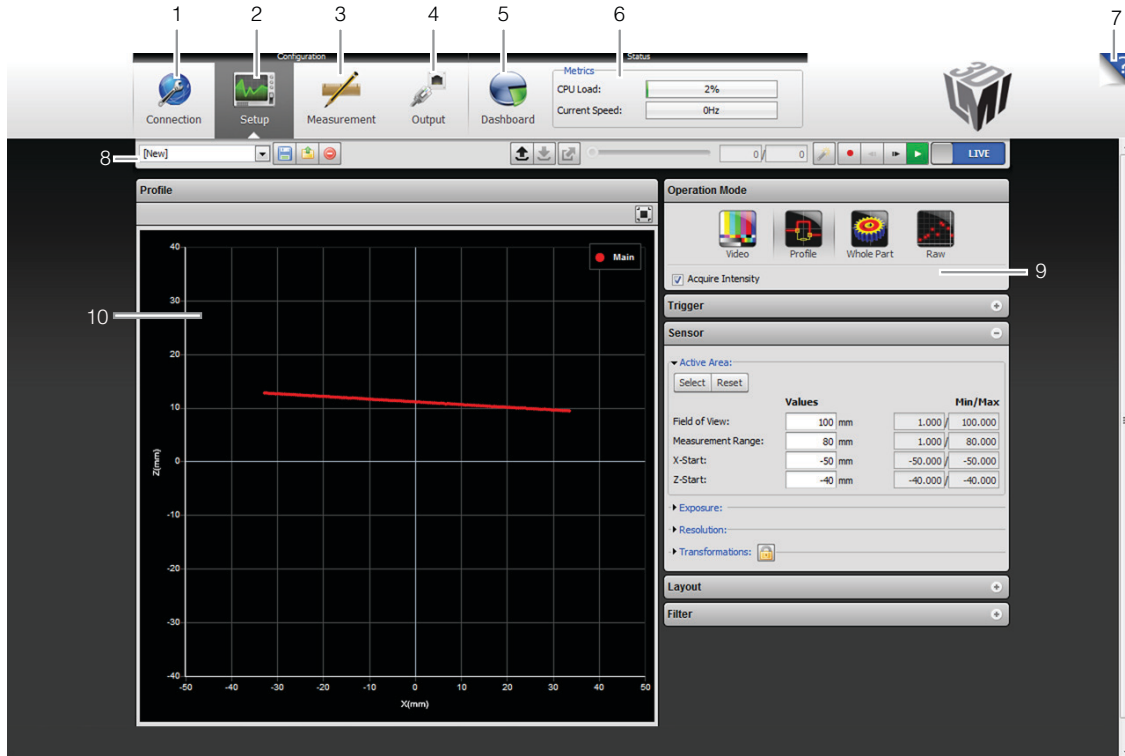

Element	Description
1	Connection Page For network configuration and maintenance.
2	Setup Page For configuring settings such as trigger source and exposure, and to perform calibration steps.
3	Measurement Page For configuring measurements.
4	Output Page For configuring measurement result outputs to external devices.
5	Dashboard Page For viewing performance statistics and results.
6	Metric Panel Summarizes important performance statistics.
7	Help Online help resources, including User Manual, Firmware updates, and SDK.
8	Toolbar Controls sensor operation, manages configurations and replays recorded measurement data.
9	Configuration Area Provides controls to configure profiling and measuring parameters.
10	Data Viewer Displays sensor data, tool setup controls, and measurements.

## Connecting to a New Sensor

Sensors are shipped with the following default network configuration:

Setting	Default
DHCP	Disabled
IP Address	192.168.1.10
Subnet Mask	255.255.255.0
Gateway	0.0.0.0

All Gocator sensors are configured to 192.168.1.10 as the default IP address. For a dual sensor system, the Main and Buddy sensors must be assigned unique addresses before they can be used on the same network. Prior to proceeding, connect the Main and Buddy sensors one at a time (to avoid an address conflict) and use the steps on page 32 to assign each sensor a unique address.

To connect to a sensor for the first time:

### 1 Connect cables and apply power.

Sensor cabling is illustrated in the System Overview (page 14)

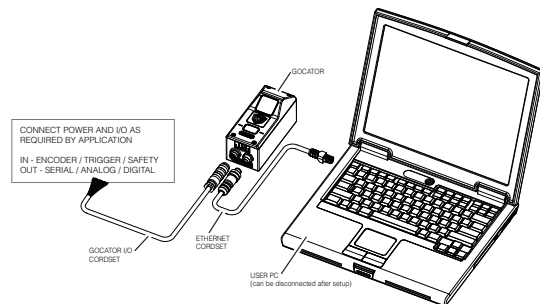

### 2 Change client network settings.

Windows 7:

- » Open the Control Panel and select Network and Sharing Center, then click Change Adapter Settings.
- » Right-click the desired network connection, and then click Properties.
- » On the Networking tab, click Internet Protocol Version 4 (TCP/IPv4), and then click Properties.
- » Select “Use the following IP address” option.
- » Enter IP Address “192.168.1.5” and Subnet Mask “255.255.255.0”, then click OK.

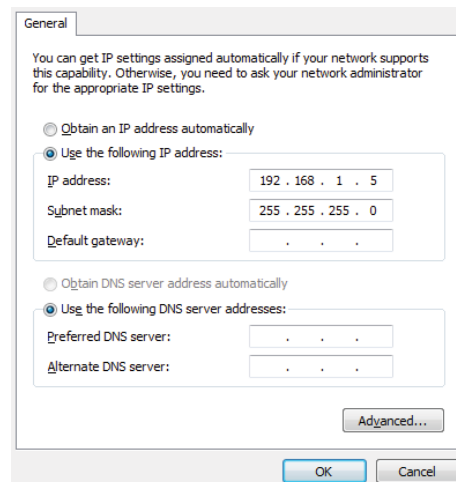

Mac OS X v. 10.6:

- » Open the Network Pane in System Preferences and select Ethernet.
- » Set Configure to “Manually”.
- » Enter IP Address “192.168.1.5” and Subnet Mask “255.255.255.0”, then click Apply.

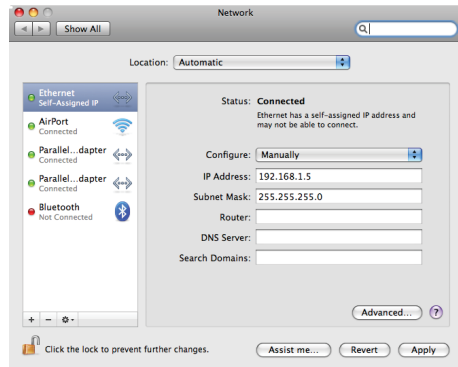

### 3 Enter the sensor's IP address 192.168.1.10 in a web browser.

Firefox 3.5+, Chrome 4.0+, and Internet Explorer 8.0+ are supported. IMPORTANT! The Adobe Flash browser plug-in, version 10.0+, must be installed.



### 4 Select the language

After selecting the language, the browser will refresh and the web interface will display in the selected language.

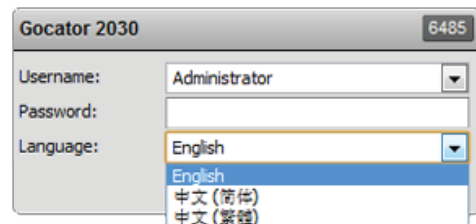

### 5 Press the Login button.

The Administrator password is initially blank.

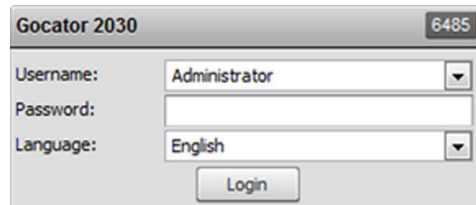

 Refer to Troubleshooting (page 209) if you experience any problems while attempting to establish a connection to the sensor.

# Running for the First Time

The Gocator is shipped with a default configuration that will produce laser ranges on most targets. The following sections walk through the steps required to setup the sensor(s) to produce laser ranges.

## Running a Standalone Sensor System

After the sensor is installed, laser profiling can be exercised to verify basic sensor operation.

*To run a sensor for the first time:*

### 1 Power up the sensor.

The power LED (blue) should turn on immediately.

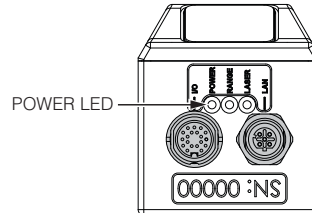

### 2 Enter the sensor's IP address 192.168.1.10 in a web browser.



### 3 Login as Administrator with no password.

The interface display language can be changed using the language option. After selecting the language, the browser will refresh and the web interface will display in the selected language.

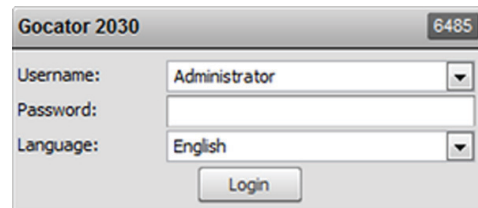

### 4 Select the Connection Page.



### 5 Specify the Connect To setting.

The Connect To setting specifies whether the sensor system is standalone, connected to a Master 200 or a Master 400/800/1200/2400. For single sensor operations select Standalone or Master 200.

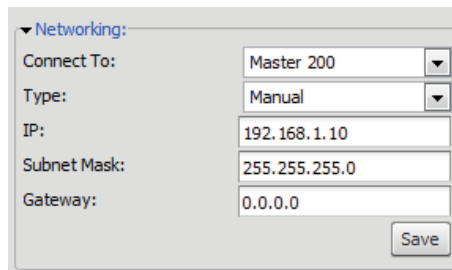

**6 Ensure that the Data Source selector is showing LIVE.**

**7 Ensure that the Laser Safety Switch is enabled or the Laser Safety input is high.**

**8 Select the Setup Page.**

**9 Press the Start button to start the sensor.**

The Start button is used to run sensors continuously, while the Snapshot button is used to trigger a single profile.

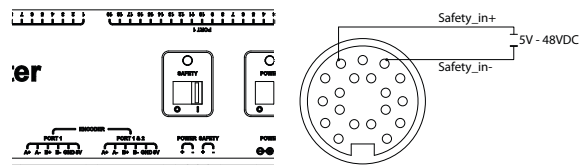
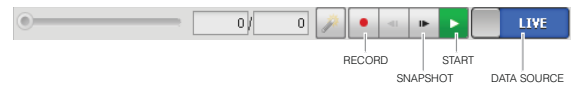

Master 200

Standalone

**10 Move a target into the laser plane.**

If a target object is within the sensor's measurement range, the Data Viewer will display the shape of the target and the sensor's range indicator LED will illuminate.

If you cannot see the laser, or if a profile is not displayed in the Data Viewer, refer to Troubleshooting (page 209).

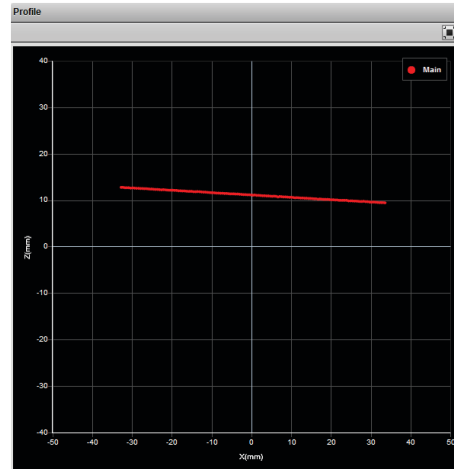

**11 Press the Stop button.**

You should now see the laser turns off.



## Running a Dual Sensor System

After the sensors are installed, laser profiling can be exercised to verify basic sensor operation.

 If Master 200 is used and an encoder input is required, the encoder signals must be connected to the Encoder (Port 1 & 2). Refer to Master 200 (page 18) for more details.

*To run a dual sensor setup for the first time:*

### 1 Unplug the Ethernet network connection of the Main sensor.

All sensors are shipped with a default IP address of 192.168.1.10. Ethernet networks require a unique IP address for each device. Skip step 1 to 3 if the Buddy sensor's IP address is already setup with an unique address.

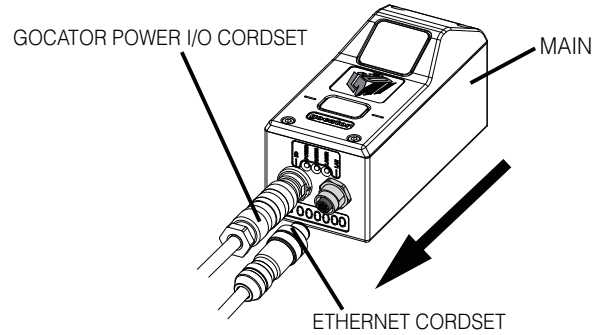

### 2 Power up the Buddy sensor.

The power LED (blue) of the buddy sensor should turn on immediately.

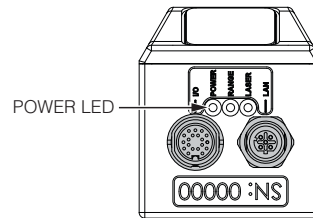

### 3 Enter the sensor's IP address 192.168.1.10 in a web browser.

This will log into the Buddy sensor.



### 4 Login as Administrator with no password.

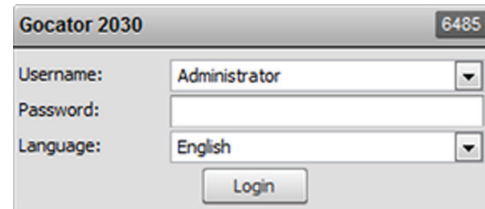

### 5 Select the Connection Page.

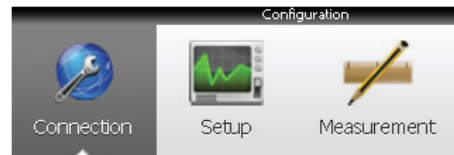

**6 Modify the IP address to 192.168.1.11 in the Network settings and click the Save button.**

When you click the Save button, you will be prompted to confirm your selection.

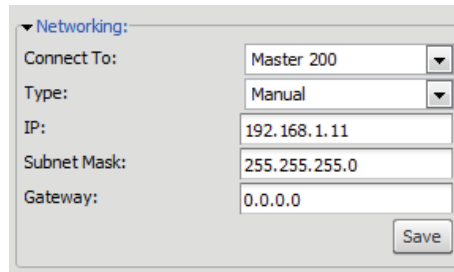

**7 Turn off the sensors, re-connect the Main sensor's Ethernet connection and power-cycle the sensors.**

After changing network configuration, the sensors must be reset or power-cycled before the change will take effect.

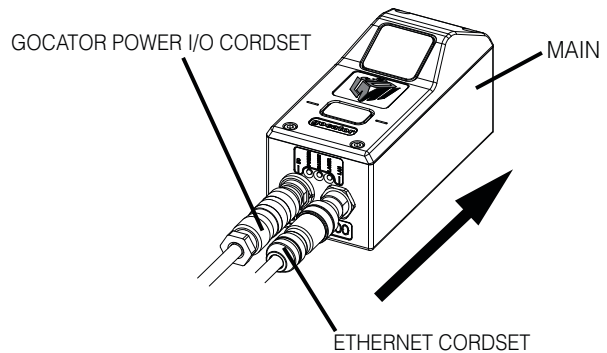

**8 Enter the sensor's IP address 192.168.1.10 in a web browser.**

This will log into the Main sensor.



**9 Login as Administrator with no password.**

The interface display language can be changed using the language option. After selecting the language, the browser will refresh and the web interface will display in the selected language.

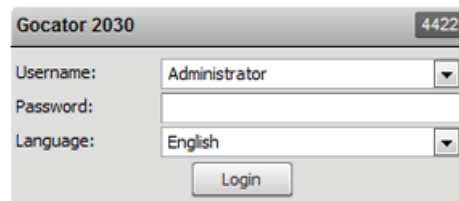

**10 Select the Connection Page.**



### 11 Specify the Connect To setting.

The Connect To setting specifies whether the sensor system is standalone, connected to a Master 200 or a Master 400/800/1200/2400. For dual sensor operation select Master 200 or Master 400/800/1200/2400.

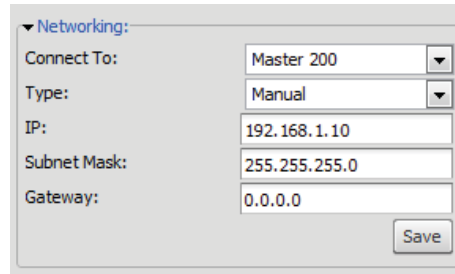

### 12 Go to Connection Page > Available Sensors panel.

The serial number of the Buddy sensor is listed in the Available Sensors panel.

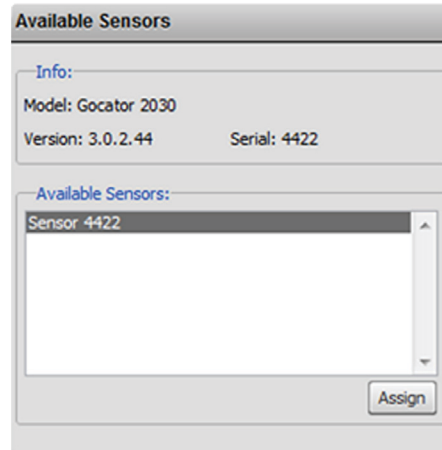

### 13 Select the Buddy sensor. Click the Assign button.

The Buddy sensor will be assigned to the Main sensor and its status will be updated in the System panel.

The firmware on Main and Buddy sensors must be the same for Buddy assignment to be successful. If the firmware is different, connect the Main and Buddy sensor one at a time and follow the steps in Firmware Upgrade (page 149) to upgrade the sensors.

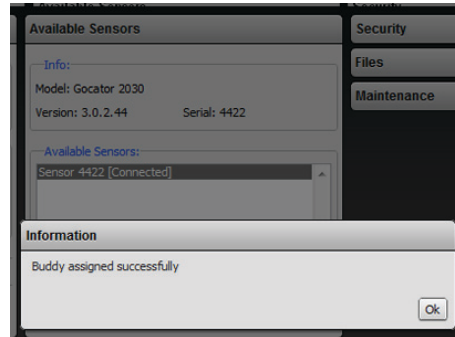

### 14 Ensure that the Data Source selector is showing LIVE.



### 15 Ensure that the Laser Safety Switch is enabled or the Laser Safety input is high.

### 16 Select the Setup Page.

### 17 Press the Start button to start the sensors.

The Start button is used to run sensors continuously, while the Snapshot button is used to trigger a single profile.

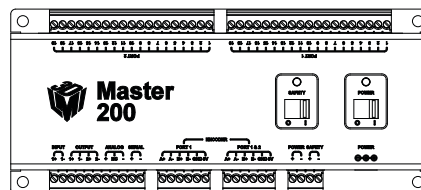

Master 200

### 18 Move a target into the laser plane.

If a target object is within the sensor's measurement range, the Data Viewer will display the shape of the target and the sensor's Range Indicator LED will illuminate.

Click the Main and Buddy button under the Setup Page to view the profile data for the main and buddy sensor

If you cannot see the laser, or if a profile is not displayed in the Data Viewer, refer to Troubleshooting (page 209).

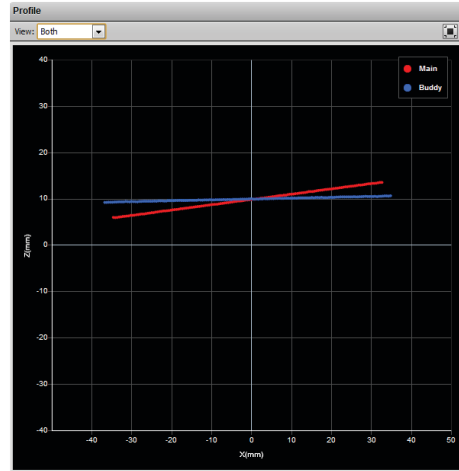

### 19 Press the Stop button.

You should now see the lasers turn off.

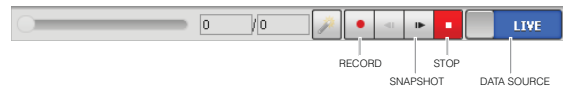

## Next Steps

After completing the steps in this chapter, the Gocator measurement system is ready to be configured for an application using the software interface. The interface is explained in the following chapters:

### **Setup and Calibration (page 37)**

Fine tunes laser profiling for an application.

### **Measurement (page 72)**

Programs measurements on sensors that are equipped with *profile tools*.

### **Output (page 123)**

Profile data, measurements, and Pass/Fail results can be transmitted to external devices for process control or data analysis.

### **Toolbar (page 132)**

Controls system operation, record and playback data, and manages sensor configurations.

### **Dashboard (page 139)**

Provides real-time monitoring of its health and measurement results.

### **Connection and Maintenance (page 142)**

Setups the sensor connections, networking and performs maintenance tasks.

# Setup and Calibration

## Setup Page

This chapter describes the steps to configure Gocator sensors for laser profiling using the Setup Page. Setup and calibration steps should be performed before programming measurements or outputs.

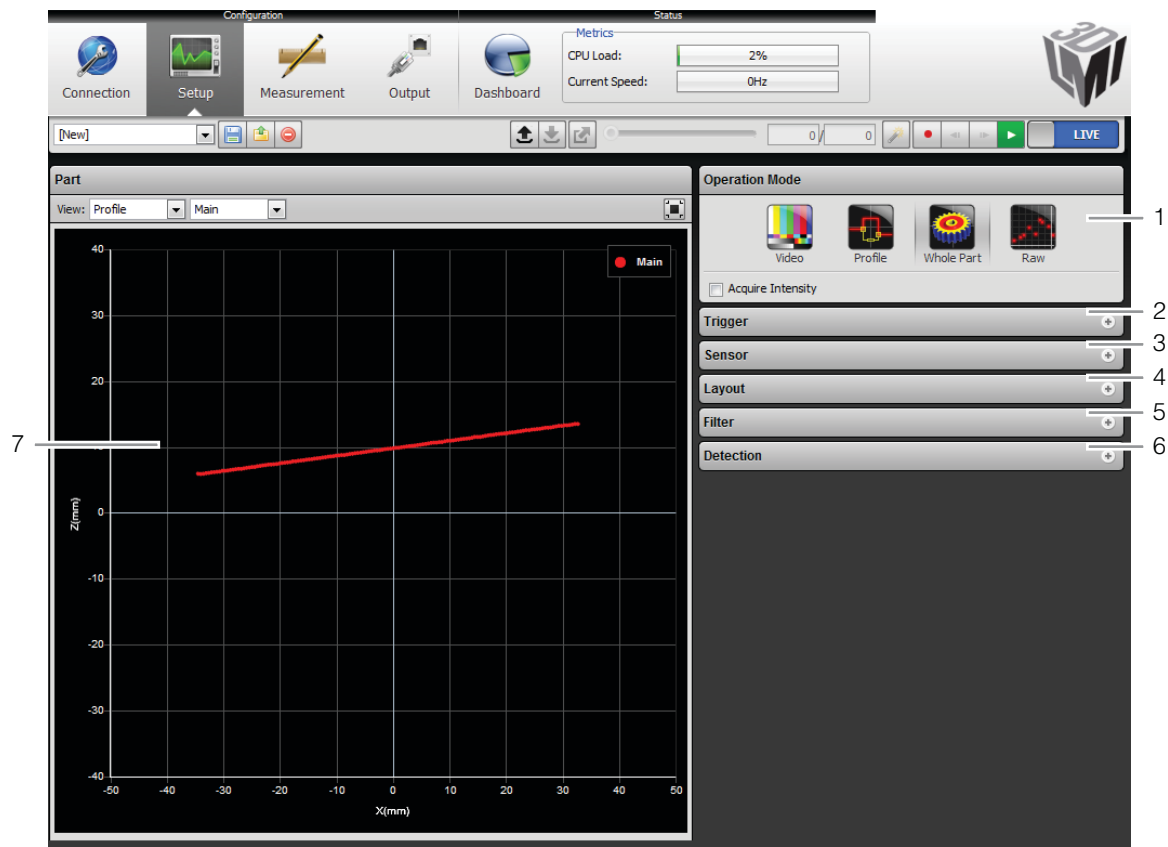

Element	Description
1	Operation Mode Panel Use the Operation Mode panel to set the current operation mode (Video, Profile, Part or Raw) and other options.
2	Trigger Panel Use the Trigger panel to specify the trigger source and trigger related settings.
3	Sensor Panel Use the Sensor panel to specify settings for an individual sensor, such as active area or exposure.
4	Layout Panel Use the Layout panel to configure the dual sensor system and to perform alignment or travel calibration.
5	Filters Panel Use the Filters panel to specify settings for post processing of the profiles.
6	Part Detection Panel Use the Part Detection panel to set the part detection logic for sorting profiles into discrete objects.

<b>Element</b>	<b>Description</b>
7 Data Viewer	Use the Data Viewer to display sensor data and adjust regions of interest. Depending on the current operation mode, the data viewer can display video images, profile plots or part views.

The following table provides quick references for specific goals that users could achieve from the panels in the setup page.

<b>Goal</b>	<b>References</b>
1 Select a trigger source that is appropriate for the application.	Trigger (page 48)
2 Ensure that camera exposure is appropriate for laser profiling.	Exposure (page 54)
3 Find the right balance between profile quality, speed, and CPU utilization.	Active Area (page 53) Exposure (page 54) Resolutions (page 58)
4 Specify mounting orientations for dual sensor systems.	Dual Sensor System Layout (page 61)
5 Calibrate the system so that laser profile data can be aligned to a common reference and values can be correctly scaled in the axis of motion.	Alignment Calibration (page 64) Travel Calibration (page 65)
6 Specify smoothing, gap-filling and resampling parameters to remove effects of occlusions.	Filters (page 67)
7 Setup the part detection logic to sort profiles into discrete objects.	Part Detection (page 71)

# Operation Modes

The Gocator web interface supports four *operation modes*: Video, Profile, Raw and Whole Part. The operation mode can be selected in the Operation Mode panel.

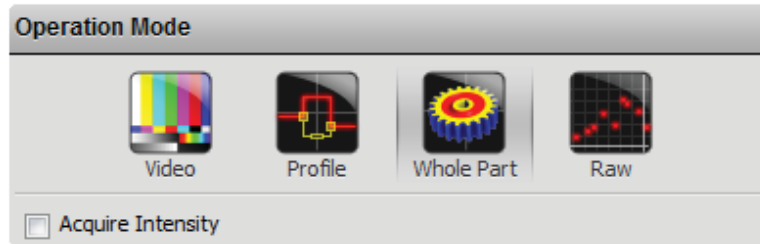

Mode and Option	Description
Video	Output video images from the Gocator. This mode is useful for configuring exposure time and troubleshooting stray light or ambient light problems.
Profile	Output profiles and perform profile measurements. Video images are processed internally to produce laser profiles and cross-sectional measurements.
Whole Part	Output 3D point clouds and perform part measurements. Laser profiles are sorted into discrete parts. The parts are then processed internally to produce measurements . "Whole Part" is often referred to as "Part" in the Gocator web interface and in this document.
Raw	Output profiles. In Raw Mode, video images are processed internally by the sensor to produce laser profiles. Use this mode to extract unprocessed ranges from the Gocator at the highest possible rate. Post-profiling processing and measurements are disabled.
Acquire Intensity	When enabled, an intensity value will be produced for each laser profile point.

# Data Viewer

The Data Viewer can display video images, profile plots, intensity images and height maps. It is also used to configure active area and measurement tools. Its use is dependent on the current operation mode and the panel selection.

## Video Mode

The Data Viewer displays camera images. In a dual sensor system, camera images from the Main or the Buddy sensor can be displayed.

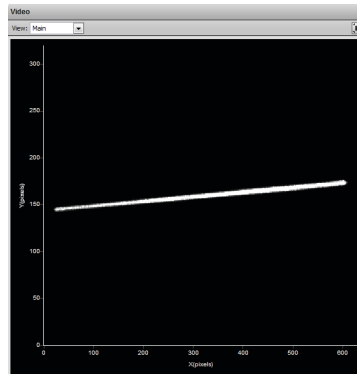

*To select the view of the display:*

**1 Navigate to the Setup Page.**

**2 Select the View.**

Select the Main or the Buddy sensor from the drop-down list at the top of the Data Viewer.

## Profile and Raw Mode

In Profile and Raw mode, the Data Viewer displays profile plots.

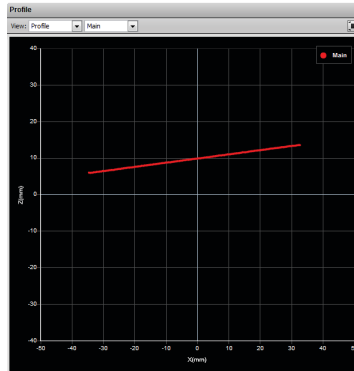

In a dual sensor system, profiles from individual sensors or from a combined view can be displayed. While in the Setup Page, selecting a panel (e.g. Sensor Panel or Layout Panel) will automatically set the display to the most appropriate display view.

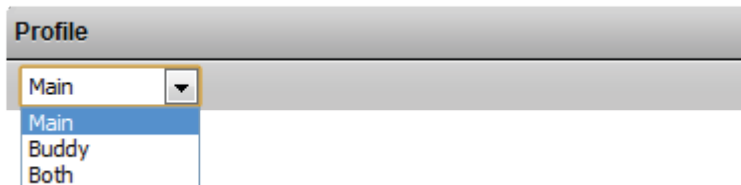

To manually select the display view in the Setup Page:

### 1 Navigate to the Setup Page.

### 2 Select the View.

An individual sensor or the combined view can be selected from the drop-down list at the top of the Data Viewer.

In the Measurement Page, the view of the display is set to the Profile Source of the selected measurement tool (page 76).

The Data Viewer can also be used to define a region of interest.

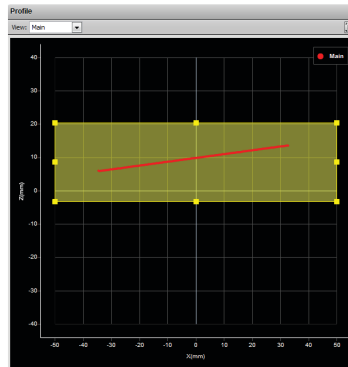

*To setup a region of interest:*

**1 Move the mouse cursor to the rectangle.**

The rectangle is automatically displayed when a setup or measurement requires an area to be specified.

**2 Drag the rectangle to move it, and use the handles on the rectangle's border to resize it.**

## Whole Part

In addition to displaying profiles, the Data Viewer can display height maps and intensity images of the detected objects.

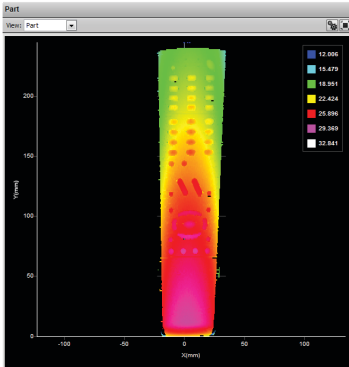

Data Viewer displaying height map

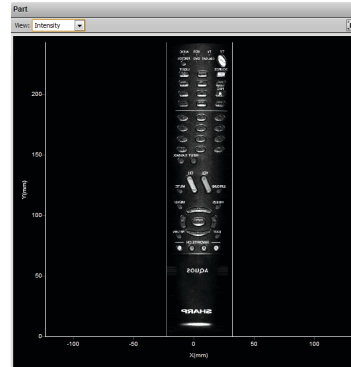

Data Viewer displaying intensity image

In a dual sensor system, data from individual sensors or from a combined view can be selected. While in the Setup Page, selecting a panel (e.g. Sensor Panel, Layout Panel or Part Detection panel) will automatically set the display to the most appropriate display type and display view.

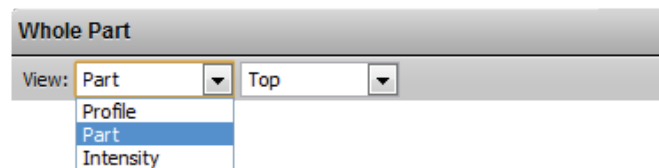

To manually select the display type and the display view in the Setup Page:

### 1 Navigate to the Sensor Page.

### 2 Select the View.

Profile, Part and Intensity can be selected from the left drop-down list. An individual sensor or the combined view can be selected from the right drop-down list.

Height maps are displayed in pseudo-color; the height (Z) axis is color coded. The scaling of the colors to the height values can be adjusted.



*To change the scaling of the height map:*

**1 Select Height Map from the View setting.**

**2 Click the Scaling button.**

This will bring up the range scaling dialog box. To manually set the scale, uncheck the Auto Range option. Enter the minimum and maximum height to which the colors will be mapped.

# Profile Output

Profile measures the height of the object calculated from laser triangulation. The Gocator reports a series of ranges along the laser line. Each range contains a height and a position in the sensor's field of view.

## Coordinate Systems

Range data is reported in sensor or system coordinates depending on the calibration state. The coordinate systems are described below.

### Sensor Coordinates

Prior to calibration, individual sensors use the coordinate system shown here.

The *z-axis* represents the sensor's measurement range (MR), with the values increasing towards the sensor.

The *x-axis* represents the sensor's field of view (FOV).

The origin is at the center of the MR and FOV.

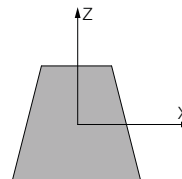
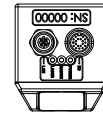

### System Coordinates

Alignment calibration or travel calibration can be used to establish a common coordinate system for the Main and Buddy sensors. Calibration determines the adjustments to X, Z, and *Tilt* (rotation in the X-Z plane) required to align the data from each sensor.

System coordinates are aligned such that the system x-axis is parallel to the calibration target surface. The system Z-origin is set to the base of the calibration target object.

For Wide and Opposite layouts, profiles and measurements from the Main and Buddy sensors are expressed in a unified coordinate system. Isolated layouts express results using a separate coordinate system for each sensor.

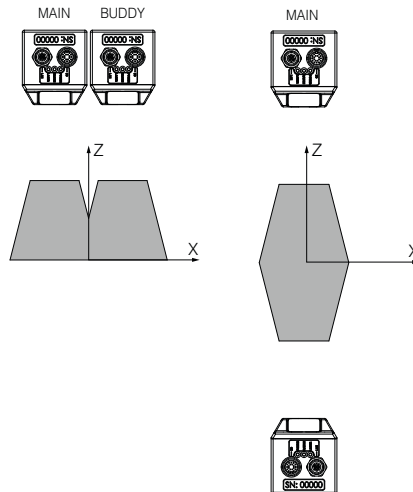

## Resampled And Raw Profile Format

Profile data produced by Profile or Part mode are processed differently than by Raw Mode. In Profile or Part mode, the ranges are resampled to an even interval along the laser line (x-axis). The resampling divides the x-axis into fixed size "bins" at even intervals. Profile points that fall into the same bin will be combined into a single range value (z). The size of the resampling interval can be configured in the Filters panel (page 67).

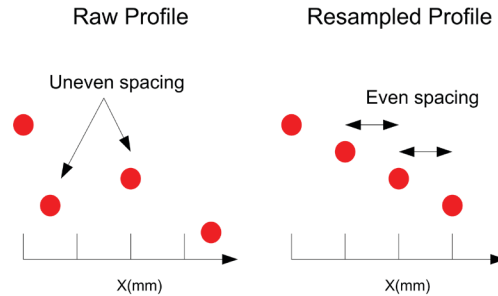

In the Ethernet data channel, only the range values (z) are reported and the x-positions can be reconstructed through the array index at the receiving end (the client).

Resampling reduces the complexity for downstream algorithms to process the profile data from the Gocator, but at the cost of higher processing load on the sensor's CPU.

In contrast, Raw Mode outputs unprocessed range data. Ranges are reported in (x,z) coordinate pairs, freeing up processing resources in the Gocator, but typically requiring more complicated processing on the client side.

All built-in measurement tools in the Gocator operate on resampled data in Profile or Part Mode.

# Intensity Output

Gocator sensors can produce intensity images that measure the amount of light reflected by an object. An 8-bit intensity value is output for each range value along the laser line. Gocator applies the same coordinate system and resampling logic as the ranges (page 45) to the intensity values.

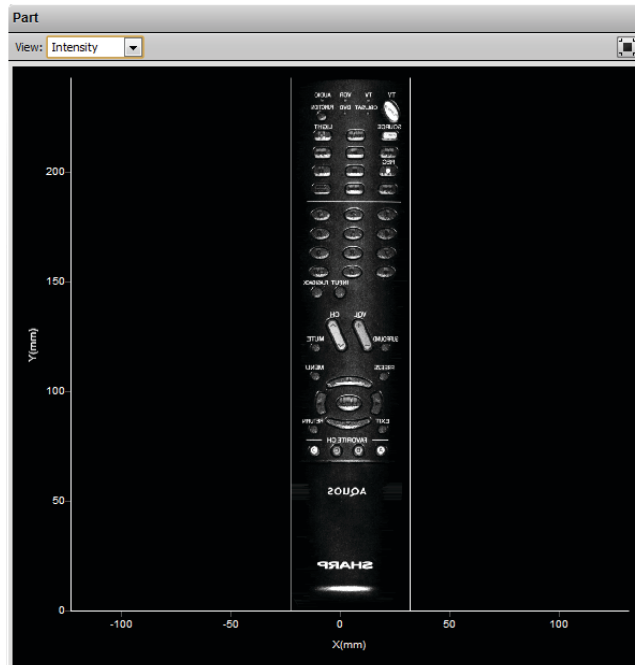

# Trigger

A trigger is an event that causes a sensor to take a single picture. When a trigger is processed, the laser is strobed and the camera exposes to produce an image. The resulting image is processed inside the sensor to yield a *laser profile* (range/distance information), which can then be used for measurement.

The laser and camera inside a sensor can be triggered by one of four sources:

Trigger Source	Description
Time	Sensors have an internal clock that can be used to generate fixed-frequency triggers. The external input can be used to enable or disable the time triggers.
Encoder	<p>An encoder can be connected to provide triggers in response to motion. Three encoder triggering behaviors are supported:</p> <ol style="list-style-type: none"> <li>1. Ignore Backward</li> </ol> <p>A scan is triggered only when the target object moves forward. If the target object moves backward, it must move forward by at least the distance of one encoder spacing to trigger a scan.</p>

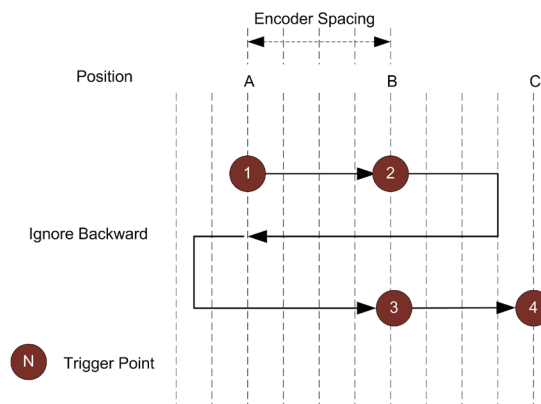

## 2. Track Backward

A scan is triggered when the target object moves forward. If the target object moves backward, it must move forward by at least the distance that the target travelled backward, plus one encoder spacing, to trigger a scan.

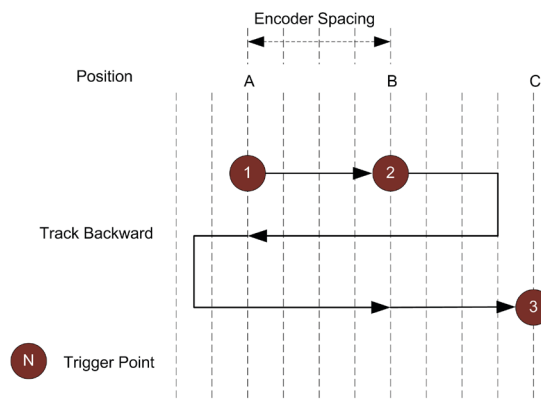

Trigger Source	Description
Encoder	<p data-bbox="435 193 606 221">3. Bi-directional</p> <p data-bbox="435 233 1202 262">A scan is triggered when the target object moves forward or backward.</p> <div data-bbox="643 294 1187 695" data-label="Diagram"> </div> <p data-bbox="435 737 1361 822">When triggers are received at a frequency higher than the maximum frame rate, some triggers may not be accepted. The <i>Trigger Drops Indicator</i> in the Dashboard can be used to check for this condition.</p> <p data-bbox="435 834 1225 862">The external input can be used to enable or disable the encoder triggers.</p> <p data-bbox="435 874 1361 929">Refer to Encoder Input (page 228) for more information on connecting the encoder to Gocator sensors.</p>
External Input	<p data-bbox="435 947 1318 975">A digital input can provide triggers in response to external events (e.g. photocell).</p> <p data-bbox="435 987 1361 1072">When triggers are received at a frequency higher than the maximum frame rate, some triggers may not be accepted. The <i>Trigger Drops Indicator</i> in the Dashboard can be used to check for this condition.</p> <p data-bbox="435 1084 1361 1139">Refer to Digital Inputs (page 228) for more information on connecting external input to Gocator.</p>
Software	<p data-bbox="435 1155 1361 1209">A network command can be used to send a software trigger. Refer to Gocator Protocol (page 151) for more information.</p>

## Examples

### Example: Encoder + Conveyor

Encoder triggering is used to perform profile measurements at a uniform distance.

The speed of the conveyor can vary while the object is being measured; an encoder ensures that the measurement spacing is consistent, independent of conveyor speed.

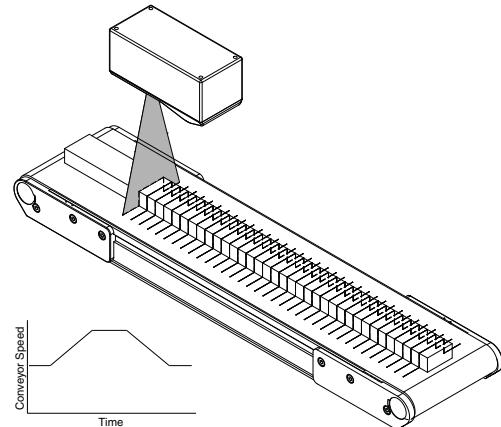

### Example: Time + Conveyor

Time triggering can be used instead of encoder triggering to perform profile measurements at a fixed frequency.

Measurement spacing will be non-uniform if the speed of the conveyor varies while the object is being measured.

It is strongly recommended to use an encoder with transport-based systems due to the difficulty in maintaining constant transport velocity.

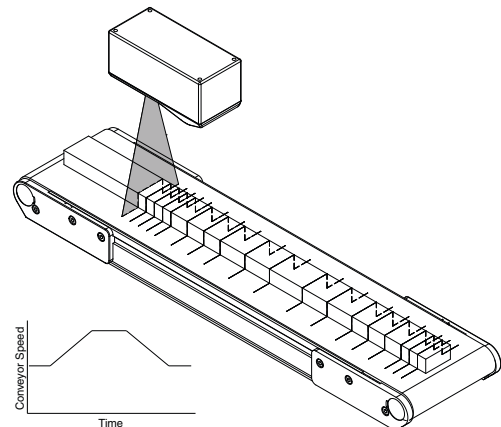

### Example: External Input + Conveyor

External Input triggering can be used to produce a snapshot for profile measurement.

For example, a photocell can be connected as an External Input to generate a trigger pulse when a target object has moved into position.

An External Input can also be used to gate the trigger signals when Time or Encoder triggering is used. For example, a photocell could generate a train of trigger pulses as long as there is a target in position.

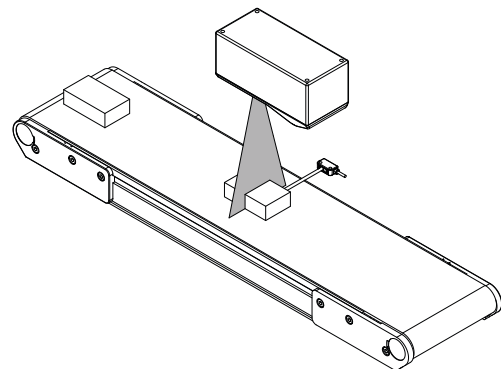

**Example: Software Trigger + Robot Arm**

Software triggering can be used to produce a snapshot for profile measurement.

A software trigger can be used in systems that employ external software to orchestrate the activities of system components.

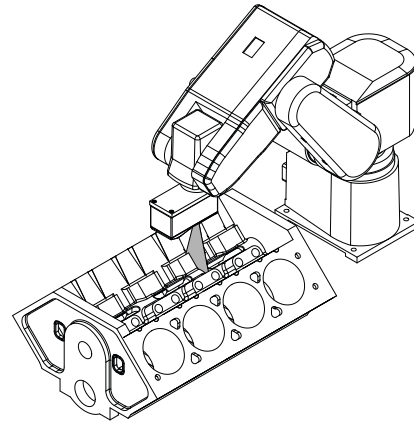

## Settings

The trigger source is selected using the Trigger panel in the Setup page.

Trigger panel with Source: Time. Max Frame Rate: 304.943 Hz. Gate using External Input: . Travel Speed: 39.33197579 mm/s. Frame Rate: 304.943 Hz  Max.

Trigger panel with Source: Encoder. Max Frame Rate: 304.943 Hz. Gate using External Input: . Behavior: Bi-directional. Resolution: 0.031 mm/tick. Spacing: 1 mm.

Trigger panel with Source: External Input. Max Frame Rate: 304.943 Hz. Units: us (Time). Trigger Delay: 0 us.

Trigger panel with Source: Software. Max Frame Rate: 304.943 Hz. Units: us (Time).

After specifying a trigger source, the Trigger Panel will show the parameters that can be configured.

Parameters	Trigger Source	Description
Trigger	All	Selects the trigger source. (Time, Encoder, External Input, or Software)
Max Frame Rate	All	Reports the maximum frame rate, which is a function of the current Active Area, Exposure, and Resolution settings.
Frame Rate	Time	The Frame Rate setting can be used to control the frame rate. Select the Max check box to lock to the maximum frame rate. Fractional values are supported. For example, 0.1 can be entered to run at 1 frame every 10 seconds.
Gate using External Input	Time, Encoder	External input can be used to enable or disable profiling in a sensor. When enabled, the sensor will respond to time or encoder triggers only when the external input is asserted. Refer to Digital Inputs (page 228) for more information on connecting external input to a Gocator sensor.
Travel Speed	Time	Travel Speed provides proper scaling in the y-axis (axis of motion). Travel Speed can be calculated automatically by performing Travel Calibration or set manually after clicking on the unlock button.
Encoder Behavior	Encoder	Encoder Behavior setting is used to specify how the Gocator sensor is triggered when the target moves.
Encoder Resolution	Encoder	Encoder Resolution (millimeters per tick) provides proper scaling in the y-axis (axis of motion). The encoder resolution can be calculated automatically by performing Travel Calibration or set manually after clicking on the unlock button.
Spacing	Encoder	Encoder Spacing setting is used to specify the distance between triggers (mm). Internally the Gocator sensor rounds the spacing to a multiple of the encoder resolution.
Units	External Input, Software	Units specifies whether the trigger delay, output delay and output scheduled command operates in time or in encoder. The unit is implicitly set to microseconds with Time trigger source, and millimeters with Encoder trigger source.
Trigger Delay	External Input	Trigger delay can be used to control the time or spacing the sensor waits before a frame after the external input is activated. This is used to compensate for the positional difference between the source of the external input trigger (e.g. photocells) and the sensor.

# Active Area

Active area refers to a region of interest within the sensor's maximum field of view that defines the area used for laser profiling.

By default, the active area covers the sensor's entire field of view. By reducing the active area, the sensor can operate at higher speeds.

Active area is specified in sensor coordinates, rather than system coordinates. Refer to Coordinate Systems (page 45) for more information on sensor and system coordinates.

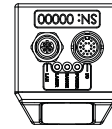

 Active Area can only be set when the sensor is not calibrated or using "None" layout (or a single sensor system)

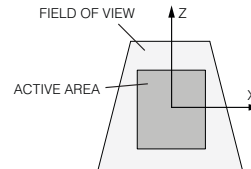

*To set the active area:*

## 1 Navigate to the Sensor panel.

Active area is specified separately for each sensor. Click the arrow next to Active Area to expand the panel.

## 2 Click the Select button.

If the Select Active Area button is disabled, then calibration may need to be cleared. Refer to Clearing Calibration (page 66) in this chapter for information on clearing calibration.

## 3 Position and resize the Active Area rectangle shown in the Data Viewer.

## 4 Click the Save button.

 Laser profiling devices are usually more accurate at the near end of the measurement range. If your application requires a measurement range that is small relative to the maximum measurement range of the sensor, mount the sensor such that the active area can be specified at the near end of the measurement range.

# Exposure

Exposure determines the duration of camera and laser on-time. Longer exposures can be helpful to detect laser signals on dark or distant surfaces, but increasing exposure time decreases the maximum speed. Different target surfaces could require different exposures for optimal results. Gocator sensors provide three exposure modes for the flexibility needed to scan different types of target surfaces.

Exposure Mode	Description
Single Exposure	Uses single exposure for all objects. Used when the surface is uniform and is the same for all targets.
Dynamic Exposure	Automatically tuned exposures. Used when the target surface varies between scans.
Multiple Exposures	Uses multiple exposures to create a single profile. Used when the target surface has a varying reflectance within a single profile (e.g. white and black color)

Video mode enables you to see how the laser appears on the camera and to identify any stray light or ambient light problems. When exposure is tuned correctly, the laser line should be clearly visible along the entire length of the viewer. If it is too dim, increase the exposure value; if it is too bright decrease exposure value.

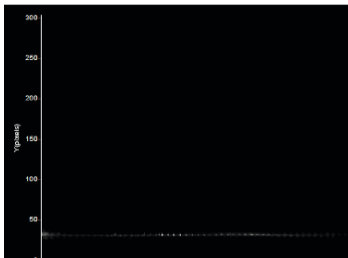

*Under exposure*

Laser line is not detected.  
Increase the exposure value.

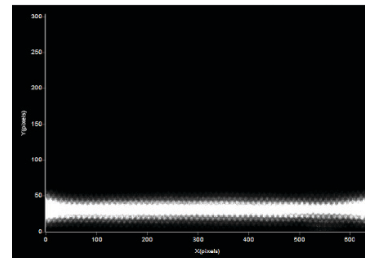

*Over exposure*

Laser line is too bright.  
Decrease the exposure value.

## Single Exposure

The sensor uses a fixed exposure in every scan. This is used when the target surface is uniform and is the same for all parts.

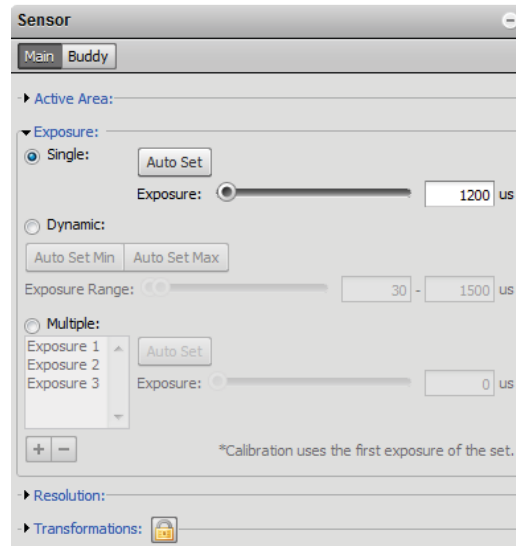

To enable single exposure:

### 1 Place a representative target in view of the sensor.

The target surface should be similar to the material that will normally be measured.

### 2 Select Profile, Part or Raw Mode.

### 3 Navigate to the Sensor panel.

Click the arrow next to Exposure to expand the panel. Click the Main or Buddy sensor button to select the sensor.

### 4 Select Single.

### 5 Edit the exposure setting.

The auto-set function can be used to automatically tune the exposure. Press the Auto Set button and the sensor will turn on and automatically tune the exposure time.

### 6 Run the sensor and check that laser profiling is satisfactory.

If not satisfactory, adjust the exposure values manually. Switch to Video mode to use video to help tune the exposure (page 54).

## Dynamic Exposure

The sensor automatically uses past profile information to adjust the exposure to yield the best profile. This is used when the target surface changes from scan to scan.

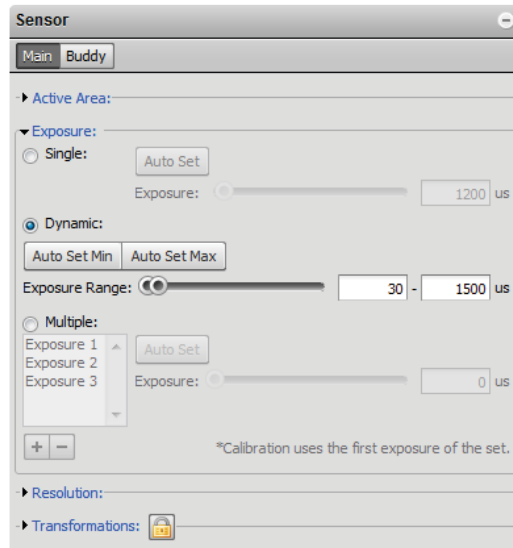

To enable dynamic exposure:

**1 Select Profile, Part or Raw Mode.**

**2 Navigate to the Sensor panel for the Main or Buddy sensor.**

Click the arrow next to Exposure to expand the panel. Click the Main or Buddy button to select the sensor.

**3 Select Dynamic.**

**4 Set the minimum and maximum exposure.**

The auto-set function can be used to automatically set the exposure. First, place the brightest target in the field of view and press the Auto Set Min button to set the minimum exposure. Then, place the darkest target in the field of view and press the Auto Set Max button to set the maximum exposure.

**5 Run the sensor and check that laser profiling is satisfactory.**

If not satisfactory, adjust the exposure values. Switch to Video mode to use video to help tune the exposure (page 54).

## Multiple Exposures

The sensor combines data from multiple exposures to create a single laser profile. Multiple exposures can be used to increase the ability to detect light and dark materials that are in the field of view simultaneously.

Up to five exposures can be defined with each set to a different exposure level. For each exposure the sensor will perform a complete scan at the current frame rate making the effective frame rate slower. For example, if two exposures are selected then the speed will be halved of the single exposure frame rate. The sensor will perform a complete scan for each external input or encoder trigger.

The resulting profile is a composite created by combing data collected with different exposures. The sensor will choose profile data that is available from the lowest numbered exposure step. It is recommended to use larger exposure for higher numbered step.

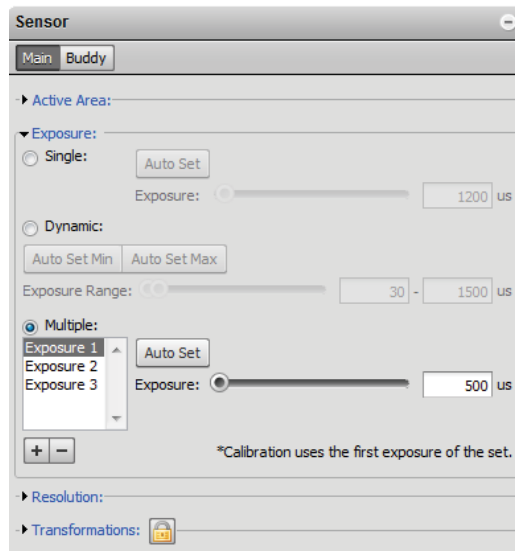

To enable multiple exposures:

### 1 Select Profile, Part or Raw Mode.

### 2 Navigate to the Sensor panel.

Click the arrow next to Exposure to expand the panel. Click the Main or Buddy button to select the sensor.

### 3 Select Multiple.

### 4 Press the + button to add an exposure step.

Up to a maximum of five exposure settings can be added.

### 5 Set the exposure level to make the Gocator less or more sensitive (as required).

The auto-set function can be used to automatically set the exposure. To use the auto-set function, place target material in the field of view then select an exposure step and press the Auto Set button. Repeat this procedure for each exposure step.

### 6 Run the sensor and check that laser profiling is satisfactory.

If not satisfactory, adjust the exposure values. Switch to Video mode to help tune the exposure (page 54).

# Resolutions

Resolutions can be set independently for the x-axis and z-axis. Reducing the resolution increases speed or reduces CPU utilization while maintaining the sensor's field of view.

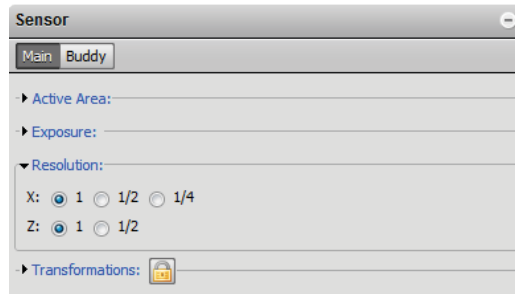

## X Resolution

The X Resolution setting can be used to decrease the profile's x-resolution in order to decrease sensor CPU utilization. The X Resolution setting works by reducing the number of image columns used for laser profiling.

 The CPU Load bar at the top of the interface displays how much of the CPU is being utilized.

*To configure X resolution:*

### 1 Navigate to the Sensor panel.

Click the arrow next to Resolution to expand the panel. Click the Main or Buddy button to select the sensor. X resolution is specified separately for each sensor.

### 2 Select a resolution value.

X resolution values are expressed as fractions. For example, a resolution value of 1/2 indicates that every second camera column will be used for laser profiling.

### 3 Check that laser profiling is satisfactory.

After adjusting the resolution, confirm that laser profiling characteristics are satisfactory.

## Z Resolution

The Z Resolution setting can be used to decrease the profile's Z resolution in order to increase speed or decrease sensor CPU utilization. The Z Resolution setting works by reducing the number of image rows that is used for laser profiling.

*To configure Z resolution:*

### **1 Navigate to the Sensor panel.**

Click the arrow next to Resolution to expand the panel. Click the Main or Buddy button to select the sensor. Z resolution is specified separately for each sensor.

### **2 Select a resolution value.**

Z resolution values are expressed as fractions. For example, a resolution value of  $1/2$  indicates that every second camera row will be used for laser profiling.

### **3 Check that laser profiling is satisfactory.**

Decreasing z resolution can reduce laser profiling accuracy. After adjusting the resolution, confirm that laser profiling characteristics are satisfactory.

# Transformations

The transformation settings are used to control how ranges are converted from sensor coordinates to system coordinates.

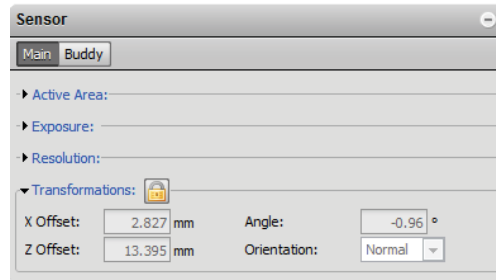

Element	Description
X Offset	Specifies the shift along the x-axis. With Normal orientation, a positive value shifts the profiles to the right. With Reverse orientation, a positive value shifts the profile to the left.
Z Offset	Specifies the shift along the z-axis. A positive value shifts the profiles up.
Angle	Specifies the tilt (rotation in the X-Z plane). A positive value rotates the profile counter-clockwise.
Orientation	Specifies the direction of the x-axis. Setting to Reverse will flip the profile about the z-axis.

To configure transformation settings:

- 1 Select the Profile, Part or Raw Mode.**
- 2 Navigate to the Sensor panel.**  
Click the arrow next to Transformation to expand the panel. Click the Main or Buddy button to select the sensor. Transformations can be configured separately for each sensor (click the arrow next to Transformations to expand the settings).
- 3 Click the unlock button to make the fields editable.**
- 4 Set the parameter values.**
- 5 Check that the transformation settings are applied correctly after profiling is restarted.**



# Dual Sensor System Layout

Mounting orientations need to be specified for a dual sensor (Buddy) system. This information allows the Alignment or Travel Calibration procedures to determine the correct system-wide coordinates for laser profiling and measurements. Refer to Coordinate Systems (page 45) in this chapter for more information on sensor and system coordinates.

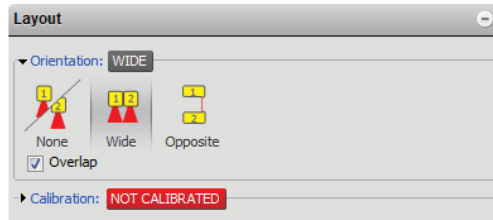
To specify the layout, navigate to the Layout panel on the Setup Page:

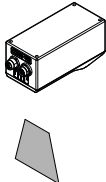

## Supported Orientations

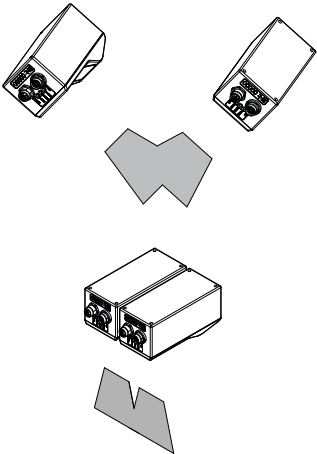
Orientation	Example
 <b>None (Isolated)</b> Each sensor operates as an isolated device. Measurements are reported in a separate coordinate system for each sensor.	
 <b>Wide</b> Sensors are mounted in <i>Left</i> (Main) and <i>Right</i> (Buddy) positions for a larger combined field of view. Sensors may be angled to avoid occlusions.	

---

**Orientation**

---

**Example**

---

**Opposite**

Sensors are mounted in *Top* (Main) or *Bottom* (Buddy) positions for a larger combined measurement range and the ability to perform Top/Bottom differential measurements.

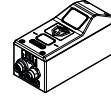
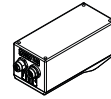

## Overlap

If the Main and Buddy sensors are mounted such that the camera from one sensor can detect the laser from the other sensor, the *Overlap* feature can be used to eliminate laser interference. Overlap creates a time offset for laser exposures and ensures that interfering lasers are not strobed at the same time. Use of the overlap feature may reduce the maximum frame rate.

# Calibration

Although Gocator sensors are pre-calibrated and ready to deliver profiles out of the box, calibration procedures are required to compensate for sensor mounting inaccuracies, to align multiple sensors into a common coordinate system, and to determine the resolution (with encoder) and speed of the transport system.

Gocator sensors support two types of calibration procedures: *Alignment Calibration* and *Travel Calibration*. Travel calibration performs essentially the same role as alignment calibration, but calibrates encoder resolution and y-axis offsets in addition to the corrections provided by alignment calibration.

Once calibration has been completed, the values derived will be saved automatically and reloaded each time the sensor is reset or powered up.

## Calibration States

A Gocator can be in one of three calibration states: None, Manual, or Auto.

### *Calibration States*

State	Explanation
None	Sensor has no calibration. Ranges are reported in default sensor coordinates.
Manual	User has manually edited transformations or encoder resolution.
Auto	Sensor is calibrated using either alignment or travel calibration.

An indicator on the Calibration panel will display CALIBRATED, MANUALLY CALIBRATED or NOT CALIBRATED.

## Alignment vs. Travel Calibration

The table below summarizes the differences between alignment calibration and travel calibration.

### *Alignment Calibration vs. Travel Calibration*

	Alignment Calibration	Travel Calibration
Target Type	Flat Surface or Cal Bar	Cal Disk or Cal Bar
Target/Sensor Motion	Stationary	Linear Motion
Calibrates Tilt	Yes	Yes
Calibrates z-axis Offset	Yes	Yes
Calibrates x-axis Offset	Yes (Cal Bar Required)	Yes
Calibrates Encoder	No	Yes
Calibrates Travel Speed	No	Yes

Refer to Coordinate Systems (page 45) for definitions of coordinate axes. Calibration disks and bars are described in Calibration Targets (page 22).

The procedures to perform alignment calibration or travel calibration are described in the next sections. After calibration, the coordinate system for laser profiles will change from Sensor Coordinates to System Coordinates.

## Alignment Calibration

Alignment calibration can be used to compensate for mounting inaccuracies by aligning sensor data to a common reference surface (often a conveyor belt).

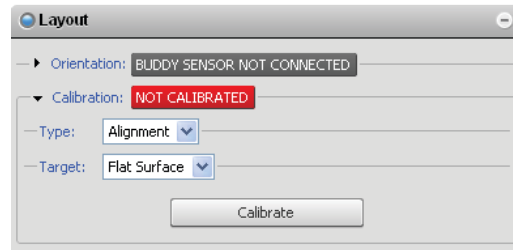

To perform alignment calibration:

### 1 Ensure that all sensors have a clear view of the target surface.

Remove any irregular objects from the sensor's field of view that might interfere with alignment calibration. If using a calibration bar for dual sensor system, ensure that the lasers illuminate a reference hole on the calibration bar.

### 2 Navigate to the Layout panel and select Alignment Calibration.

Click the arrow button next to Calibration to expand the panel.

### 3 Clear the previous calibration if present.

Press the Clear Calibration button to remove the existing calibration.

### 4 Select a calibration Target.

Select *Flat Surface* to use the conveyor surface (or other flat surface) as the calibration reference, or *Bar* to use a custom calibration bar. If using a calibration bar, specify the bar dimensions and reference hole layout. Refer to Calibration Targets (page 22) for more information.

### 5 Press the Calibrate button.

The sensors will start and the alignment calibration process will take place. Calibration is performed simultaneously for all sensors. If the sensors do not calibrate, check and adjust the exposure settings.

### 6 Use Profile Mode to inspect calibration results.

Laser profiles from all sensors should now be aligned to the calibration target surface. The base of the calibration target (or target surface) provides the origin for the system z-axis.

 Alignment calibration does not automatically calibrate the resolution of the encoder (if present) or the travel speed. However, these values can be manually entered if desired. Refer to Trigger (page 48) for more information.

## Travel Calibration

Travel calibration can be used to achieve alignment calibration and motion calibration in a single procedure.

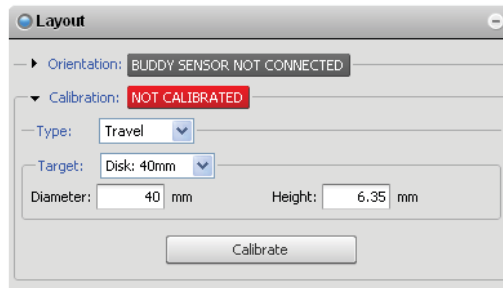

To perform travel calibration:

**1 Place the calibration target prior to the laser plane.**

Remove extraneous objects from the transport system such that the calibration target will be the only object that is scanned.

**2 Navigate to the Layout panel and select Travel Calibration.**

Click the arrow button next to Calibration to expand the panel.

**3 Clear the previous calibration, if present.**

Press the Clear Calibration button to remove the existing calibration.

**4 Select a calibration Target.**

Select one of the *Disk* options to use a standard disk target or *Bar* to use a custom-made calibration bar. If using a calibration bar, specify the bar dimensions and reference hole layout. Refer to Calibration Targets (page 22) for more information.

**5 Press the Calibrate button.**

The sensors will start and then wait for the calibration target to pass through the laser plane.

**6 Engage the transport system.**

When the calibration target has passed completely through the laser plane, the calibration process will complete automatically. To properly calibrate the travel speed, the transport system must be running at the production operating speed before the target passes through the laser plane.

**7 Use Profile Mode to inspect calibration results.**

Laser profiles from all sensors should now be aligned to the calibration target surface. The base of the calibration target (or target surface) provides the origin for the system z-axis.

## Clearing Calibration

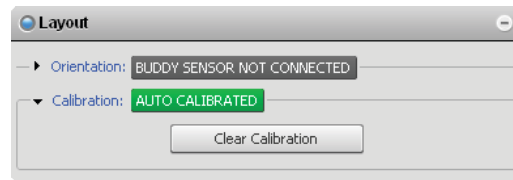

*To clear calibration:*

**1 Navigate to the Calibration panel on the Setup page.**

**2 Click the Calibration or Clear Calibration button.**

If the Clear Calibration button is pressed, the calibration will be erased and sensors will revert to using Sensor Coordinates.

# Filters

The Filters Panel can be used to post process the profile before it is output or is used by measurement tools. Three types of operations are supported:

<b>Operation</b>	<b>Description</b>
X Resampling Interval	Configure resampling interval size to balance between CPU loading, output data rate and x-resolution.
Smoothing	Apply averaging to reduce random noise in a profile.
Gap Filling	Fill in missing data caused by occlusions using information from the nearest neighbors.

## X Resampling Interval

Resampling interval is the spacing between data points in a resampled profile (page 45). A larger interval creates profiles with lower x-resolution but reduces CPU usage and potentially increases the maximum frame rate. A larger interval also reduces the data output rate.

By default, the Gocator output data at the medium resolution.

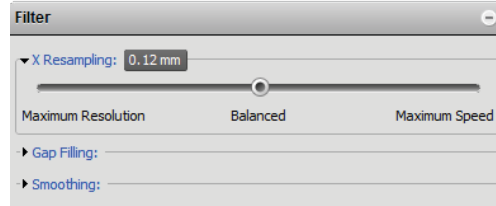

To configure the X resampling interval:

### 1 Select the Profile or Part Mode.

### 2 Navigate to the Filters panel.

Click the arrow next to X Resampling to expand the panel.

### 3 Select a resampling interval level.

**Maximum Speed:** Use the lowest x-resolution within the active area as the resampling interval. This setting minimizes CPU usage and data output rate but the profile has the lowest x-resolution (i.e. least detail)

**Balanced:** Use the x-resolution at the middle of the active area as the resampling interval. This setting balances CPU load, data output rate and the x-resolution.

**Maximum Resolution:** Use the highest x-resolution within the active area as the resampling interval. This setting maximizes resolution but has higher CPU load and has the highest data output rate. (i.e. greatest detail).

## Gap Filling

Gap filling works by filling in missing data points using the lowest values from the nearest neighbors. The sensor can fill gaps along both the x-axis and the y-axis. X gap filling works by filling in the gaps within the same profile. Y gap filling works by filling in gaps in the direction of travel at each x location.

If both X and Y gap filling are enabled, missing data is filled along the x-axis first, then along the y-axis.

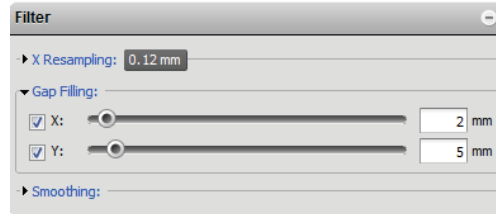

*To configure X gap filling:*

**1 Select the Profile or Part Mode.**

**2 Navigate to the Filters panel.**

Click the arrow next to Gap Filling to expand the panel.

**3 Enable X gap filling and select the maximum width value.**

The maximum gap value represents the maximum gap width that the Gocator will fill. Gaps wider than the maximum width will not be filled.

**4 Check that the laser profiling is satisfactory.**

*To configure Y gap filling:*

**1 Select the Profile or Part Mode.**

**2 Navigate to the Filters panel**

Click the arrow next to Gap Filling to expand the panel.

**3 Enable Y gap filling and select the maximum width value.**

The maximum gap value represents the maximum gap width that the Gocator will fill. Gaps wider than the maximum width will not be filled.

**4 Check that the laser profiling is satisfactory.**

## Smoothing

Smoothing works by substituting a profile result with the average value of itself and its nearest neighbors. Smoothing can be applied along the x-axis or the y-axis. X smoothing works by calculating a moving average across samples within the same profile. Y smoothing works by calculating a moving average in the direction of travel at each x location.

If both X and Y smoothing are enabled, the data is smoothed along x-axis first, then along the y-axis.

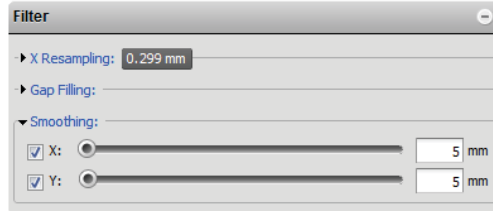

*To configure X smoothing:*

**1 Select the Profile or Part Mode.**

**2 Navigate to the Filters panel.**

Click the arrow next to Smoothing to expand the panel.

**3 Enable X Smoothing and select the window value.**

The window value represents the averaging window size in the x-axis.

**4 Check that the laser profiling is satisfactory.**

*To configure Y smoothing:*

**1 Select the Profile or Part Mode.**

**2 Navigate to the Filters panel.**

Click the arrow next to Smoothing to expand the panel.

**3 Enable Y Smoothing and select the window value.**

The window value represents the average window size in the y-axis.

**4 Check that the laser profiling is satisfactory.**

# Part Detection

In Part Mode, the Gocator sensor analyzes each profile to identify discrete objects. Part measurements can then be performed on each discrete object.

Part detection can be performed when the trigger source is set to Time or Encoder. To use the Time trigger source, the travel speed needs to be calibrated. To use the Encoder trigger source, the encoder resolution needs to be calibrated. Refer to Travel Calibration (page 65) for more information.

Multiple parts can pass through the laser at the same time and will be individually tracked. Parts can be separated along the laser line (x-axis), or in the direction of travel (y-axis).

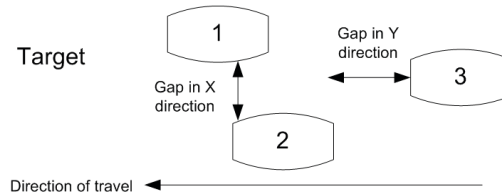

The following settings can be tuned to improve the accuracy and reliability of the part detection.

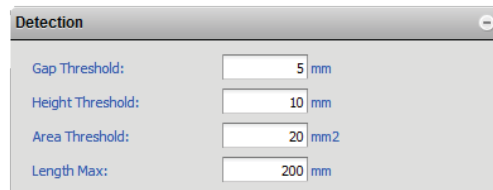

Setting	Description
Gap Threshold	Determines the minimum separation between objects in the XY plane. If parts are closer than the gap interval, they will be merged into a single part.
Height Threshold	Determines the minimum profile height for part detection. This setting is useful when measuring objects on a conveyor, to prevent the conveyor from being detected as a part.
Area Threshold	Determines the minimum area for a detected part. Set this value to a reasonable minimum in order to filter out small objects or noise.
Length Max	Determines the maximum length of the part object. When the object exceeds the maximum length, it is automatically separated into two parts. This is useful to break a long object into multiple sections and perform measurements on each section.

*To setup part detection:*

- 1 Navigate to the Operation Mode Panel, select Part Mode.**
- 2 Navigate to the Part Detection panel.**
- 3 Adjust the settings.**

# Measurement

## Measurement Page

Measurement tools are configured using the Measurement Page.

The content of the Measurement Page is controlled by the current operation mode. In Profile Mode, the Measurement Page displays tools for profile measurement. In Part Mode, the Measurement page displays tools for part measurement. The Measurement page is disabled for Video and Raw mode.

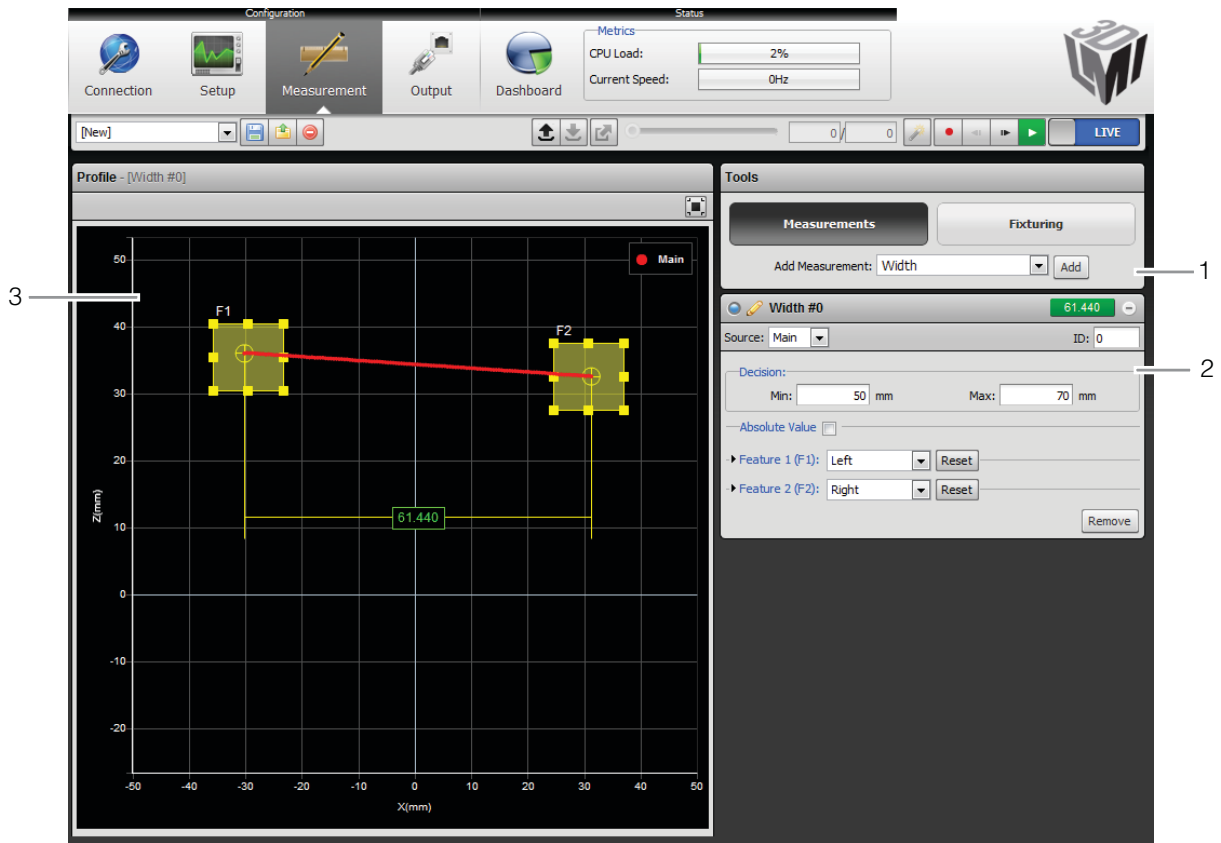

Element	Description
1	Tools Panel Use the Tools panel to add new measurements or to configure fixturing.
2	Measurement Panel For each measurement that is added, a configuration area will appear below the Measurements panel. Use this area to adjust settings for the measurement.
3	Data Viewer Displays laser profile or part data, setup tools and result calipers related to the selected measurement. Parts are displayed using a height map; A top-down view of the XY plane, where color represents height.

# Adding and Removing Measurements

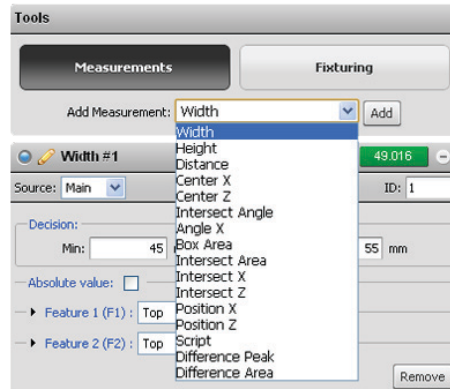

To add a new profile measurement:

**1 Select the desired measurement type.**

Click on the item in the drop-down list next to Add Measurement to select the measurement type.

**2 Press the Add button.**

A configuration panel for the new measurement will be added to the bottom of the stack.

To remove a new profile measurement:

**1 Select the desired measurement.**

Click on the title bar of the measurement to select it.

**2 Click the Remove button.**

The measurement will be removed from the list of measurements.



If the Add Measurement list contains only the *Distance* measurement, then the sensor is not equipped with profile tools. The Distance measurement is provided in all sensors to demonstrate the measurement capability.

## Changing the Measurement Name

Each measurement can be assigned a unique name. This allows multiple measurements of the same type to be distinguished in the web interface. The name is also referenced by the Script tool (page 80).

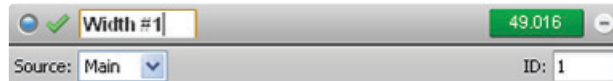

*To edit a measurement name:*

- 1 Click on the measurement name.**
- 2 Enter a new name.**
- 3 Press the Tab key.**

The name change will be completed when you press the Tab Key or click outside of the name edit field.

# Measurement ID

Measurement ID is used to uniquely identify a measurement in the Gocator protocol or in the SDK. The value must be unique amongst all profile and part measurements.



*To edit a measurement ID:*

**1 Select a measurement.**

Click on the + in a measurement panel to expand the panel.

**2 Click on the measurement ID.**

**3 Enter a new number.**

The value must be unique amongst all measurements in Profile and Part Mode.

**4 Press the Tab key.**

The name change will be completed when you press the Tab Key or click outside of the measurement ID edit field.

# Profile Sources

For dual sensor systems, measurements must specify a *profile source*. The profile source determines the data that will be used for the measurement.

The following options are available:

Profile Source	Description
Main	Profile data is provided by the Main sensor. This is the only option for standalone systems.
Buddy	Profile data is provided by the Buddy sensor.
Both	Profile data is provided by the Main and the Buddy sensor.

*To select the profile source:*

**1 Select a measurement.**

Click on the + in a measurement panel to expand it.

**2 Select the profile Source.**

Select the source in the drop down list. The drop down list will not appear if Main is the only option.

# Decisions

Results from a measurement tool can be compared against minimum and maximum thresholds to generate *pass / fail decisions*. The decision state is *pass* (value displayed in green) if a measurement value is between the minimum and maximum threshold, otherwise the decision state is *fail* (value displayed in red).

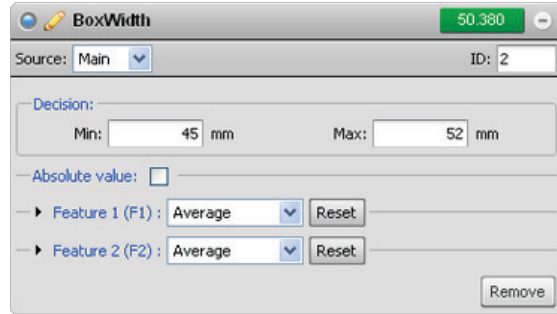
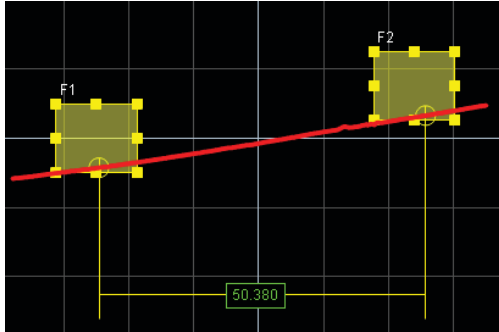

Value (50.380) is within decision thresholds (Min:45, Max:52)  
Decision: Pass

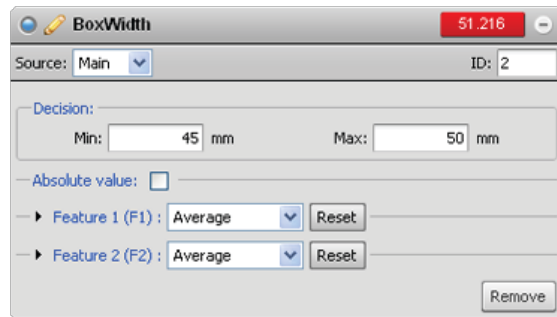
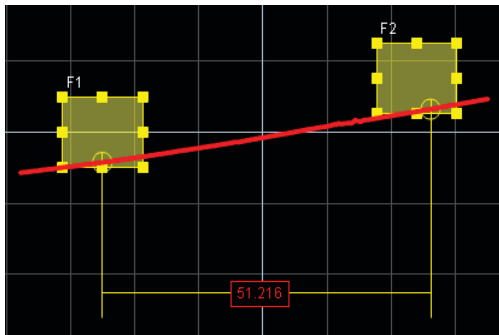

Value (51.216) is outside decision thresholds (Min:45, Max:50)  
Decision: Fail

Along with measurement values, decisions can be sent to external programs and devices. In particular, decisions are often used in conjunction with digital outputs to trigger an external event in response to a measurement. Refer to Output (page 123) for more information on transmitting values and decisions.

# Profile Fixturing

Profile fixturing is used to track the movement of parts along the laser line (x-axis). The movement is calculated as an offset and is used to correct the positions of the feature areas. This ensures that the regions-of-interest used to detect features are correctly positioned for every part.

Profile fixturing is not required in order to use measurement functions. This is an optional feature intended to make measurements more robust when the x-position of the target varies from target to target.

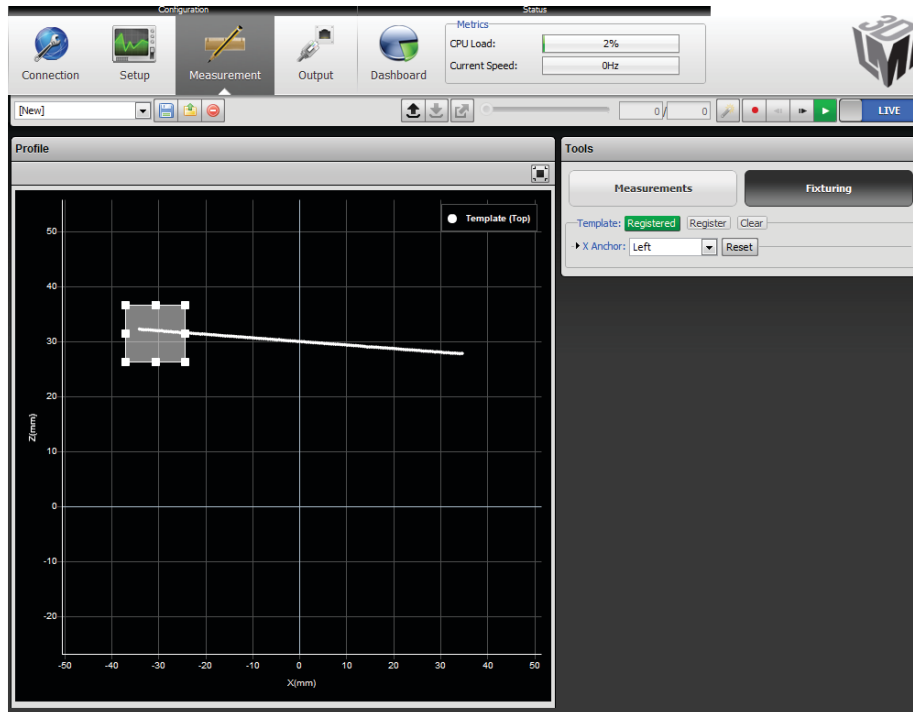

To set up profile fixturing:

**1 Press the Fixturing button in the Measurement panel.**

**2 Position a representative target object within the field of view.**

The target should be similar to the objects that will later be measured. The Start or Snapshot buttons can be used to view live profile data while positioning the target.

**3 Click the Register button.**

A snapshot of the target object will be captured and set as the current profile template. The profile template is shown in white within the Data Viewer.

**4 Adjust the anchor rectangle.**

Profile data within the anchor rectangle will be used to calculate the anchor point for fixturing.

**5 Select an anchor point type.**

The point type determines how the anchor point is calculated from the profile data within the anchor rectangle.

When profile fixturing is used, the measurement regions should be setup to match the profile template. The profile template is hidden when the sensor is running. When the sensor is stopped and the user is viewing the measurement page, the profile template will be automatically reloaded in the Data Viewer.

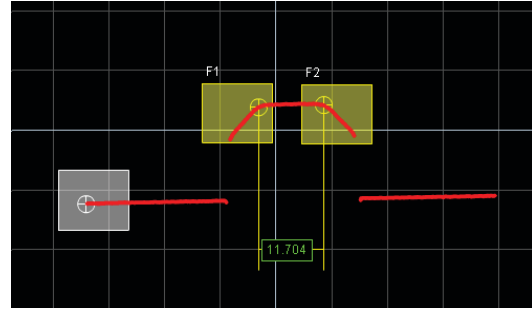
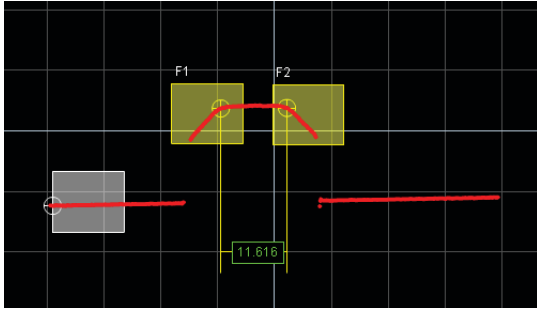

In the example above, the anchor rectangle is shown in white in the left image. When *running* the sensor, the feature areas are shifted relative to the position of the live profile (shown in white, in the right most image) to track the profile movement.

*To disable profile fixturing:*

- 1 Press the Fixturing button in the Measurements panel.**
- 2 Click the Clear button.**

Changes to profile fixturing and template are temporary until they are saved. Refer to Saving and Loading Settings (page 133) for more details on how to save changes.

# Script Measurement

A Script measurement can be used to program a custom measurement using a simplified C-based syntax. Similar to other measurement tools, a script measurement can produce a measurement value and a measurement decision.

The following elements of the C language are supported:

*Supported Elements:*

Elements	Supported
Control Operators	if, while, do, for, switch and return.
Data Types	char, int, unsigned int, long long (64-bit integer).
Arithmetic and Logical Operator	Standard C arithmetic operators, except tertiary operator (i.e. "condition? trueValue: falseValue").
Function Declarations	Standard C function declarations with argument passed by values. Pointers are not supported.

## Built-in Functions

*Built-in Functions:*

Built-in Function	Descriptions
int exists(char *name)	Tests for the existence of a measurement by name. Parameter: name – name of a measurement Return: 0 – measurement does not exist 1 – measurement exists
signed long long value (char *name)	Retrieves the value of a measurement by name. Parameter: name - name of a measurement Return: Value of the measurement 0 – if measurement does not exist
signed long long decision (char *name)	Retrieves the decision of a measurement by name. Parameter: name - name of a measurement Return: Decision of the measurement 0 – if measurement does not exist
int output(signed long long value, signed long long decision)	Output a value and decision. Only the last output value / decision in a script run is kept and passed to the Gocator output. Parameters: value - value output by the script decision - decision value output by the script. Can only be 0 or 1 Return: 0 – if not successful 1 – successful

### Example: Manhattan distance

The following example demonstrates how to create a custom measurement that is based on the values from other measurements.

```
// Constants for thresholds
signed long long decisionMin = 0;
signed long long decisionMax = 40000;

// Function to compute absolute value
signed long long abs(signed long long a)
{
    if (a > 0) return a;
    else return -a;
}
// Get the values from Width/Height measurements.
// Values are accessed with the 'value' function, and
// decisions with the 'decision' function.
signed long long width = value("Width");
signed long long height = value("Height");

// Calculate Manhattan Distance value and decision
signed long long manhattan = abs(width) + abs(height);
int result = (manhattan > decisionMin) && (manhattan < decisionMax);

// Emit final value and decision using the 'output' function
output(manhattan, result);
```

# Profile Measurement Tools

This chapter describes the profile measurement tools available in sensors that are equipped with *Profile Tools*.

Most measurement functions detect and compare *feature points* or *lines* found within laser profile data. Measurement *values* are compared against minimum and maximum thresholds to yield *decisions*.

---

## Measurement

## Examples

### Width

Measures the difference in the x-axis position of two feature points.

Refer to Width (page 88).

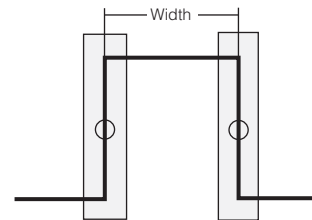

### Height

Measures the difference in the z-axis position of two features.

Refer to Height (page 89).

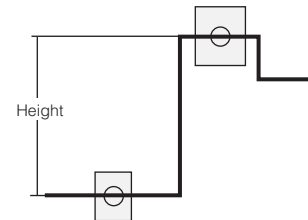

### Distance

Measures the Euclidean distance between two features.

Refer to Distance (page 90).

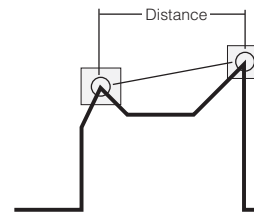

### Position X

Finds the average x-axis position of a feature.

Refer to Position X (page 91).

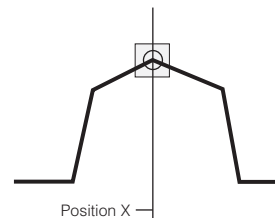

### Position Z

Finds the average z-axis position of a feature.

Refer to Position Z (page 92).

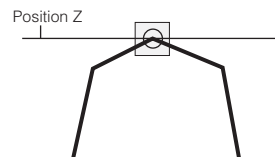

---

**Measurement****Examples**

---

**Center X**

Finds the average location of two features and measures the x-axis position of the average location.

Refer to Center X (page 93).

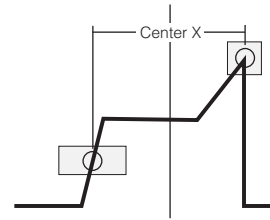
**Center Z**

Finds the average location of two features and measures the z-axis position of the average location.

Refer to Center Z (page 94).

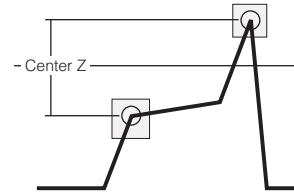
**Angle X**

Fits a line to profile points within one or two areas and measures the angle between the fitted line and the x-axis.

Refer to Angle X (page 95).

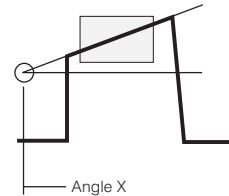
**Intersect X**

Finds the intersection between two fitted lines and measures the x-axis position of the intersection point.

Refer to Intersect X (page 96).

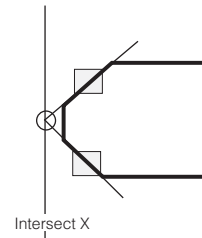
**Intersect Z**

Finds the intersection between two fitted lines and measures the z-axis position of the intersection point.

Refer to Intersect Z (page 97).

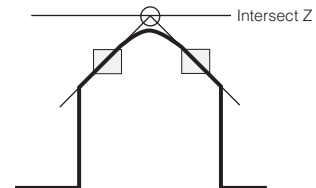
**Intersect Angle**

Finds the angle subtended by two fitted lines.

Refer to Intersect Angle (page 98).

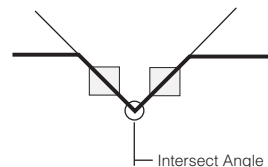

---

**Measurement**

---

**Examples****Intersect Area**

Measures the cross-sectional area within a region that is above or below a fitted baseline.

Refer to Intersect Area (page 99).

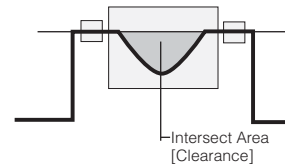
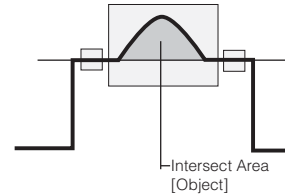
**Box Area**

Measures the cross-sectional area within a region.

Refer to Box Area (page 100).

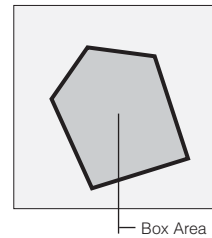
**Difference Area**

Measures the difference in cross-sectional area between live profile and the template.

Refer to Difference Area (page 101).

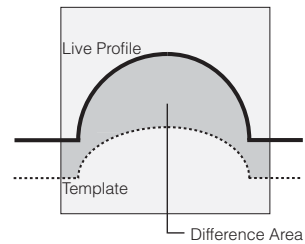
**Difference Peak**

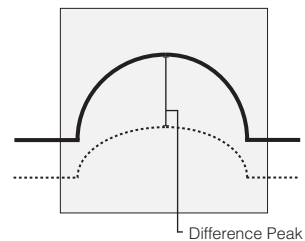

Measures the maximum difference in height between the live profile and the template.

Refer to Difference Peak (page 102).

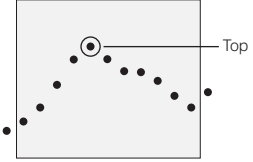
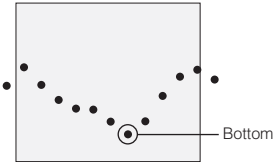

# Feature Points

Many profile measurements involve estimating the locations of feature points and then making comparisons between the feature points. The following types of points can be identified.

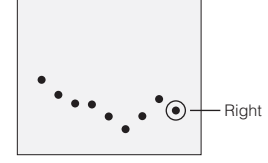
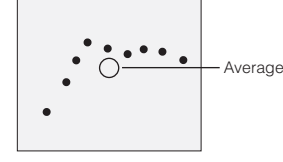
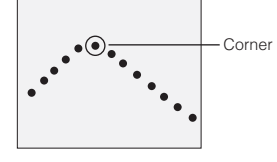
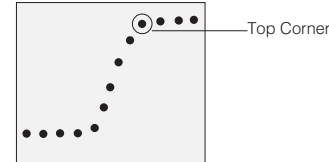
Point Type	Examples
<p><b>Top</b></p> <p>Finds the point with the maximum z-value within the region of interest.</p>	
<p><b>Bottom</b></p> <p>Finds the point with the minimum z-value within the region of interest.</p>	
<p><b>Left</b></p> <p>Finds the point with the minimum x-value within the region of interest.</p>	
<p><b>Right</b></p> <p>Finds the point with the maximum x-value within the region of interest.</p>	
<p><b>Average</b></p> <p>Determines the average location of points within the region of interest.</p>	
<p><b>Corner</b></p> <p>Finds a dominant corner within the region interest, where <i>corner</i> is defined as a change in profile slope.</p>	
<p><b>Top Corner</b></p> <p>Finds the top-most corner within the region interest, where <i>corner</i> is defined as a change in profile shape.</p>	

---

**Point Type****Examples**

---

**Bottom Corner**

Finds the bottom-most corner within the region interest, where corner is defined as a change in profile shape.

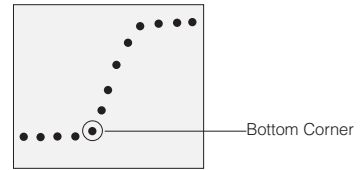
**Left Corner**

Finds the left-most corner within the region interest, where corner is defined as a change in profile shape.

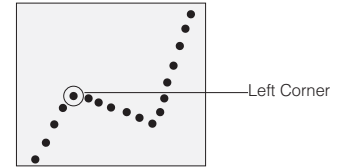
**Right Corner**

Finds the right-most corner within the region interest, where corner is defined as a change in profile shape.

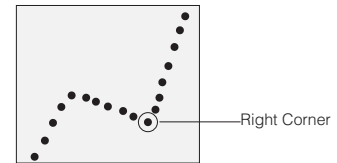
**Rising Edge**

Finds a rising edge within the region of interest.

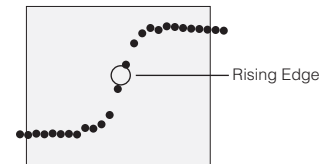
**Falling Edge**

Finds a falling edge within the region of interest.

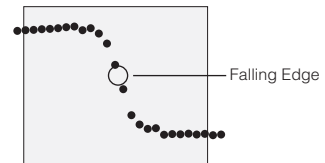
**Any Edge**

Finds a rising or falling edge within the region of interest.

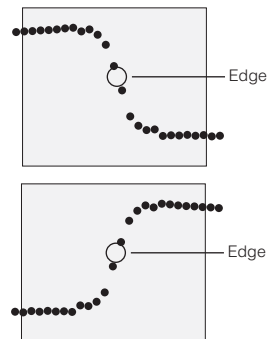
**Median**

Determines the median location of points within the region of interest.

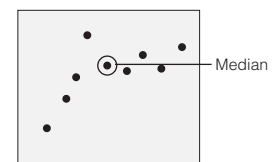

# Fit Lines

Some measurements involve estimating lines in order to measure angles or intersection points. A fit line can be calculated using data from either one or two fit areas. Refer to the following diagrams:

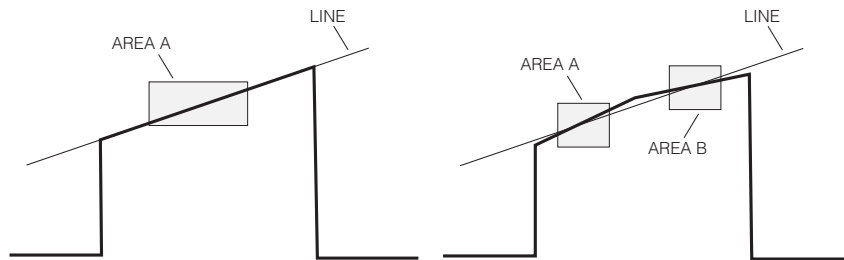

*A line can be defined using one or two areas. Two areas can be used to bypass discontinuity in a line segment.*

# Measurement Types

## Width

A width measurement determines the difference along the x-axis between two feature points. The measurement value can be compared with minimum and maximum constraints to yield a decision.

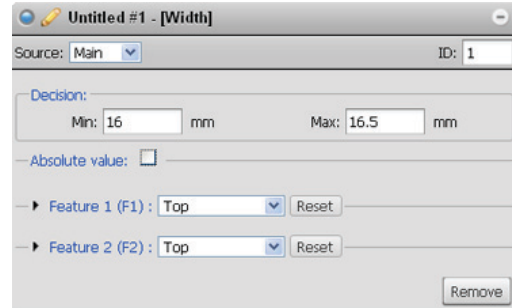
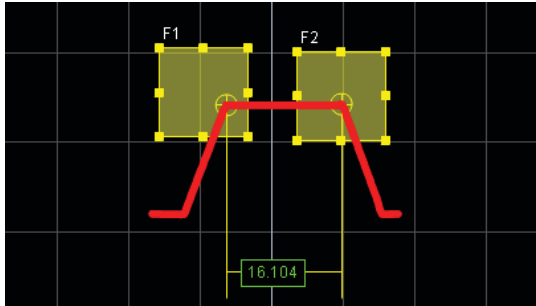

The difference can be calculated as an absolute or signed result. The difference is calculated by

$$\text{Width} = \text{Feature 2}_{x\text{-position}} - \text{Feature 1}_{x\text{-position}}$$

To create or edit a Width measurement:

- 1 Add a new Width measurement or select an existing Width measurement.**
- 2 Select the measurement Source.**  
Choices that are available depend on the system layout.
- 3 Adjust the feature point areas.**  
A Width measurement requires two feature points.
- 4 Specify the types of feature points to be detected.**  
Refer to Feature Points (page 85) in this chapter for information on point types.
- 5 Select absolute or signed result.**  
Check the Absolute box to select absolute result.
- 6 Provide minimum and maximum constraints for a decision.**  
Refer to Decisions (page 77) for more information on decisions.

## Height

A height measurement determines the difference along the z-axis between two feature points. The measurement value can be compared with minimum and maximum constraints to yield a decision.

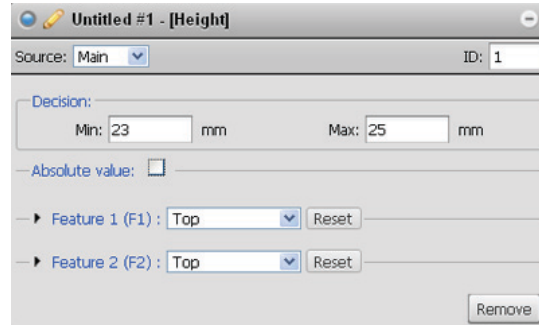
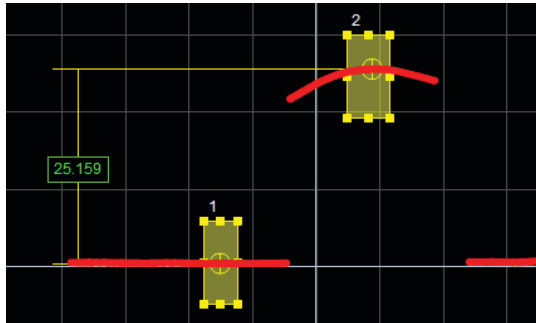

The difference can be expressed as an absolute or signed result. The difference is calculated by

$$\text{Height} = \text{Feature 2}_{z\text{-position}} - \text{Feature 1}_{z\text{-position}}$$

To create or edit a Height measurement:

- 1 Add a new Height measurement or select an existing Height measurement.**
- 2 Select the measurement Source.**  
Choices that are available depend on the system layout.
- 3 Adjust the feature point areas.**  
A Height measurement requires two feature points.
- 4 Specify the types of feature points to be detected.**  
Refer to Feature Points (page 85) in this chapter for information on point types.
- 5 Select absolute or signed result.**  
Check the Absolute box to select absolute result.
- 6 Provide minimum and maximum constraints for a decision.**  
Refer to Decisions (page 77) for more information on decisions.

## Distance

A distance measurement determines the Euclidean distance between two feature points. The measurement value can be compared with minimum and maximum constraints to yield a decision.

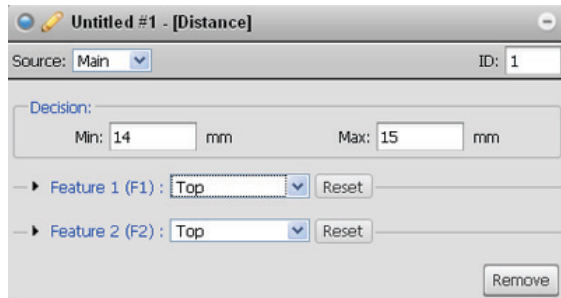
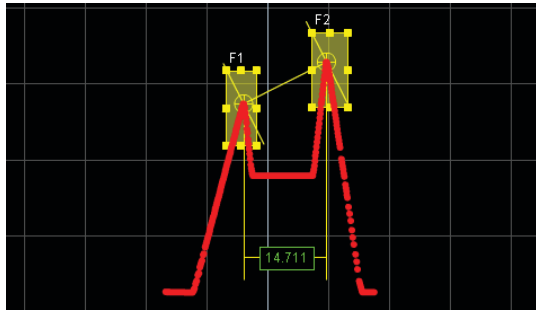

*To create or edit a Distance measurement:*

- 1 Add a new Distance measurement or select an existing Distance measurement.**
- 2 Select the measurement Source.**  
Choices that are available depend on the system layout.
- 3 Adjust the feature point areas.**  
A Distance measurement requires two feature points.
- 4 Specify the types of feature points to be detected.**  
Refer to Feature Points (page 85) in this chapter for information on point types.
- 5 Provide minimum and maximum constraints for a decision.**  
Refer to Decisions (page 77) for more information on decisions.

## Position X

A Position X measurement finds the x-axis position of a feature point. The measurement value can be compared with minimum and maximum constraints to yield a decision.

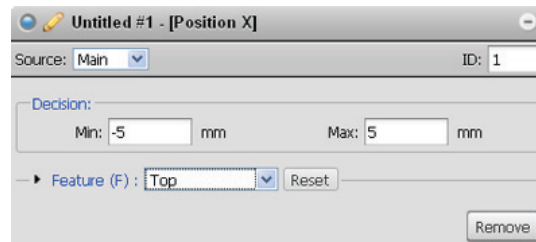
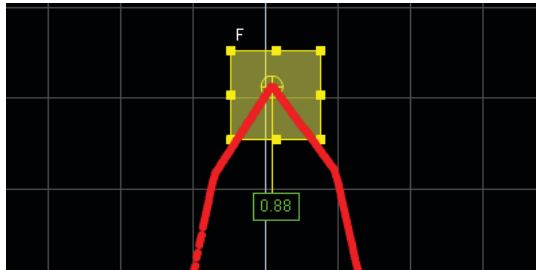

To create or edit a Position X measurement:

- 1 Add a new Position X measurement or select an existing Position X measurement.**
- 2 Select the measurement Source.**  
Choices that are available depend on the system layout.
- 3 Adjust the feature point area.**  
A Position X measurement requires one feature point.
- 4 Specify the type of feature to be detected.**  
Refer to Feature Points (page 85) in this chapter for information on point types.
- 5 Provide minimum and maximum constraints for a decision.**  
Refer to Decisions (page 77) for more information on decisions.

## Position Z

A Position Z measurement finds the z-axis position of a feature point. The measurement value can be compared with minimum and maximum constraints to yield a decision.

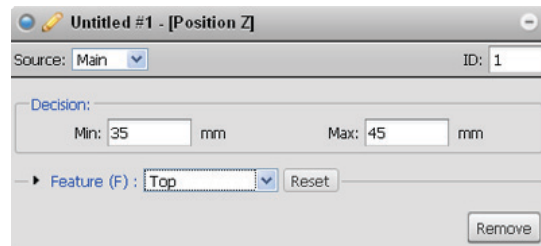
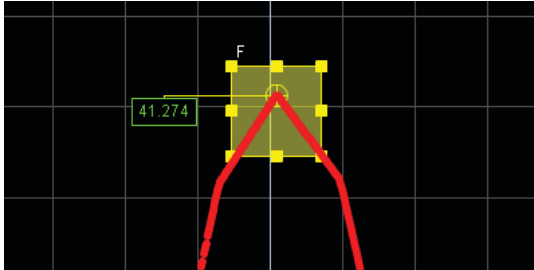

To create or edit a Position Z measurement:

**1 Add a new Position Z measurement or select an existing Position Z measurement.**

**2 Select the measurement Source.**

Choices that are available depend on the system layout.

**3 Adjust the feature point area.**

A Position Z measurement requires one feature point.

**4 Specify the type of feature to be detected.**

Refer to Feature Points (page 85) in this chapter for information on point types.

**5 Provide minimum and maximum constraints for a decision.**

Refer to Decisions (page 77) for more information on decisions.

## Center X

A Center X measurement finds the average location of two features points and measures the x-axis position of the average location. The measurement value can be compared with minimum and maximum constraints to yield a decision.

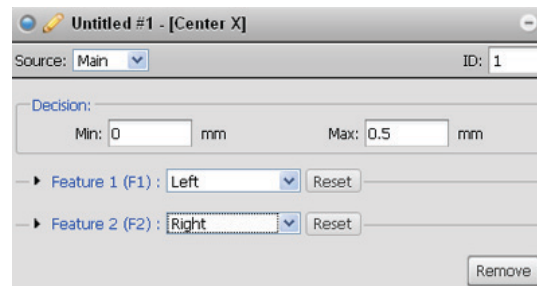
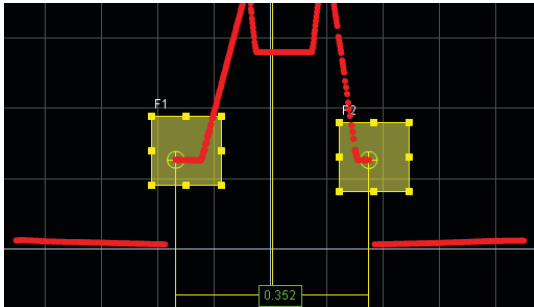

To create or edit a Center X measurement:

- 1 Add a new Center X measurement or select an existing Center X measurement.**
- 2 Select the measurement Source.**  
Choices that are available depend on the system layout.
- 3 Adjust the feature point areas.**  
A Center X measurement requires two feature points.
- 4 Specify the types of feature points to be detected.**  
Refer to Feature Points (page 85) in this chapter for information on point types.
- 5 Provide minimum and maximum constraints for a decision.**  
Refer to Decisions (page 77) for more information on decisions.

## Center Z

A Center Z measurement finds the average location of two features points and measures the z-axis position of the average location. The measurement value can be compared with minimum and maximum constraints to yield a decision.

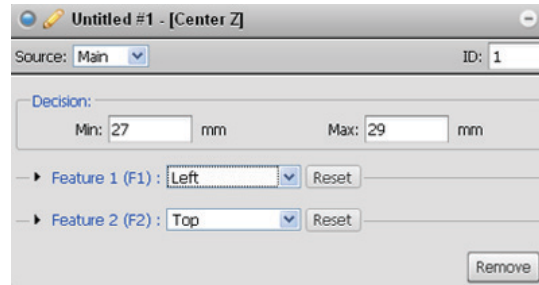
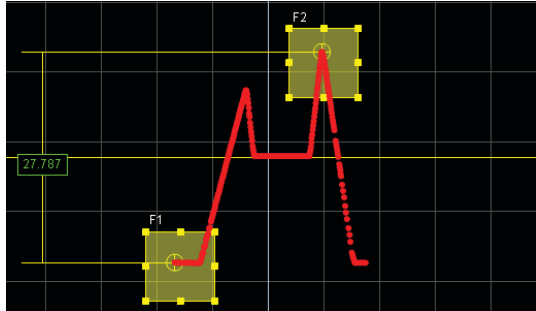

To create or edit a Center Z measurement:

- 1 Add a new Center Z measurement or select an existing Center Z measurement.**
- 2 Select the measurement Source.**  
Choices that are available depend on the system layout.
- 3 Adjust the feature point areas.**  
A Center Z measurement requires two feature points.
- 4 Specify the types of feature points to be detected.**  
Refer to Feature Points (page 85) in this chapter for information on point types.
- 5 Provide minimum and maximum constraints for a decision.**  
Refer to Decisions (page 77) for more information on decisions.

## Angle X

An Angle X measurement determines the angle between a fit line and the x axis. The measurement value can be compared with minimum and maximum constraints to yield a decision.

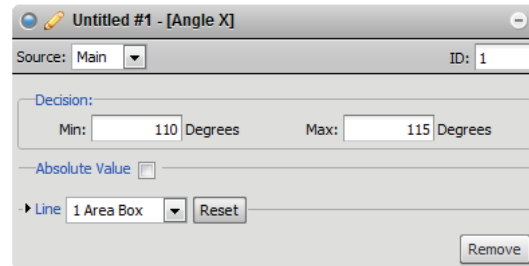

The angle can be expressed as a signed or an absolute result. The absolute result is used when the minimum and maximum constraints need to cover both positive and negative angles.

For a signed result, the angle is between -90 degrees and 90 degrees and is measured from the x-axis. Positive angle is measured counter clockwise and negative angle is measured clockwise.

For an absolute result, the angle range is between 0 degrees and 90 degrees and is the absolute value of the angle between the line and the x-axis.

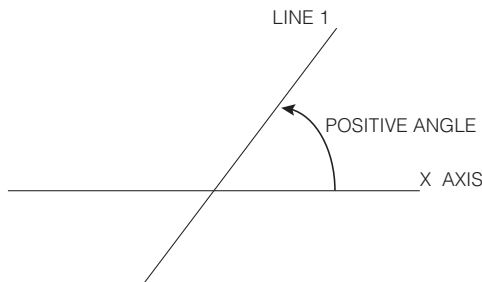

*When the angle of Line 1 is less than 90° counter clockwise from the X axis, the angle returned is positive.*

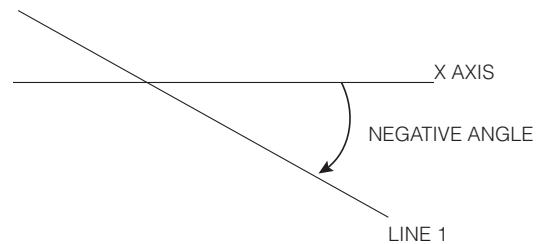

*When the angle of Line 1 is less than 90° clockwise from X axis, the angle returned is negative.*

To create or edit an Angle X measurement:

**1 Add a new Angle X measurement or select an existing Angle X measurement.**

**2 Select the measurement Source.**

Choices that are available depend on the system layout.

**3 Adjust the fit line area(s).**

An Angle X measurement requires one fit line. One or two fit areas can be used for each fit line. Refer to Fit Lines (page 87) for more information.

**4 Select absolute or signed result.**

Check the Absolute box to select absolute result.

**5 Provide minimum and maximum constraints for a decision.**

Refer to Decisions (page 77) for more information on decisions.

## Intersect X

An Intersect X measurement determines the intersection between two fit lines and measures the x-axis position of the intersection point. The measurement value can be compared with minimum and maximum constraints to yield a decision.

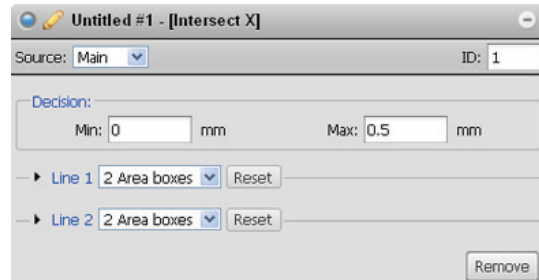
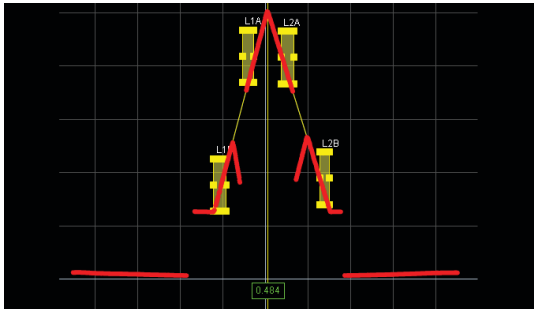

To create or edit an Intersect X measurement:

- 1 Add a new Intersect X measurement or select an existing Intersect X measurement.**
- 2 Select the measurement Source.**  
Choices that are available depend on the system layout.
- 3 Adjust the fit line area(s).**  
An Intersect X measurement requires two fit lines. One or two fit areas can be used for each fit line. Refer to Fit Lines (page 87) for more information.
- 4 Provide minimum and maximum constraints for a decision.**  
Refer to Decisions (page 77) for more information on decisions.

## Intersect Z

An Intersect Z measurement determines the intersection between two fit lines and measures the z-axis position of the intersection point. The measurement value can be compared with minimum and maximum constraints to yield a decision.

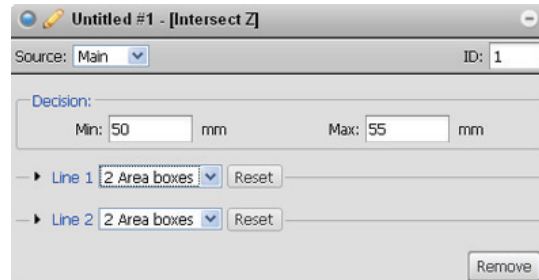
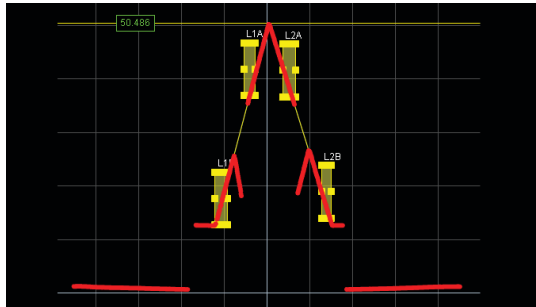

To create or edit an Intersect Z measurement:

- 1 Add a new Intersect Z measurement or select an existing Intersect Z measurement.**
- 2 Select the measurement Source.**  
Choices that are available depend on the system layout.
- 3 Adjust the fit line area(s).**  
An Intersect Z measurement requires two fit lines. One or two fit areas can be used for each fit line. Refer to Fit Lines (page 87) for more information.
- 4 Provide minimum and maximum constraints for a decision.**  
Refer to Decisions (page 77) for more information on decisions.

## Intersect Angle

An Intersect Angle measurement determines the angle subtended by two fit lines. The measurement value can be compared with minimum and maximum constraints to yield a decision.

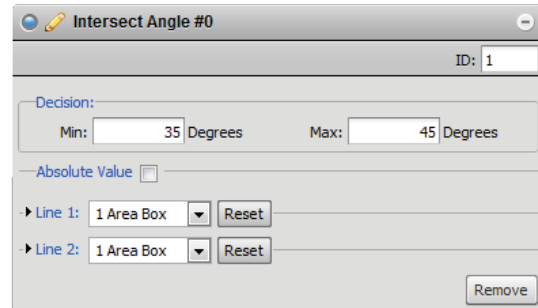
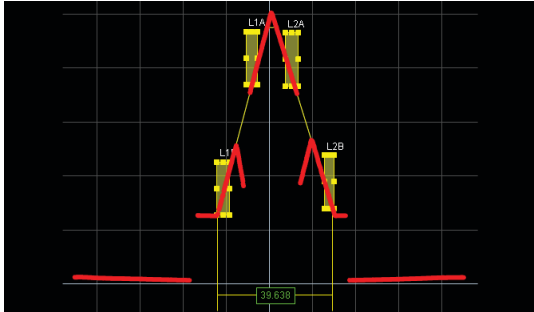

The angle can be expressed as a signed or absolute result. The absolute result is used when the minimum and maximum constraints need to cover both positive and negative angles.

For a signed result, the angle range is between -90 degrees and 90 degrees and is measured from the Line 1. Positive angle is measured counter clockwise and negative angle is measured clockwise.

For an absolute result, the angle range is between 0 degrees and 90 degrees and is the absolute value of the angle between Line 2 and Line 1.

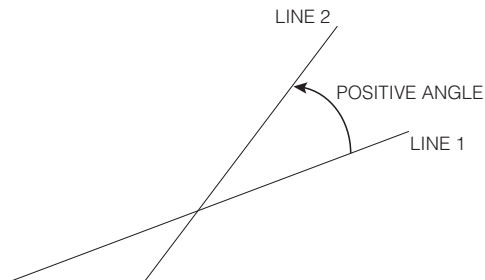

*When the angle of Line 2 is less than 90° counter clockwise from Line 1, the angle is returned positive.*

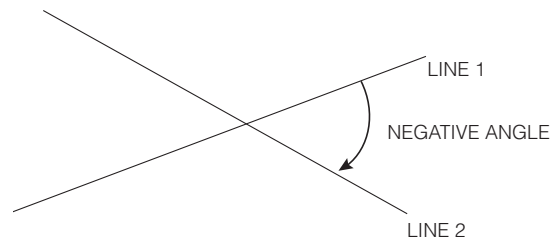

*When the angle of Line 2 is less than 90° clockwise from Line 1, the angle is returned negative.*

To create or edit an Intersect Angle measurement:

- 1 Add a new Intersect Angle measurement or select an existing Intersect Angle measurement.**
- 2 Select the measurement Source.**  
Choices that are available depend on the system layout.
- 3 Adjust the fit line area(s).**  
An Intersect Angle measurement requires two fit lines. One or two fit areas can be used for each fit line. Refer to Fit Lines (page 87) for more information.
- 4 Select absolute or signed result.**  
Check the Absolute box to select absolute result.
- 5 Provide minimum and maximum constraints for a decision.**  
Refer to Decisions (page 77) for more information on decisions.

## Intersect Area

An Intersect Area measurement determines the cross-sectional area within a region that is above a baseline. The measurement value can be compared with minimum and maximum constraints to yield a decision.

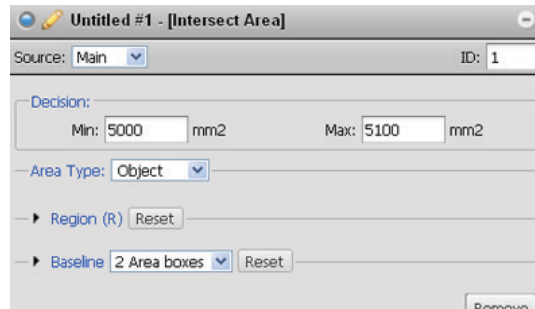
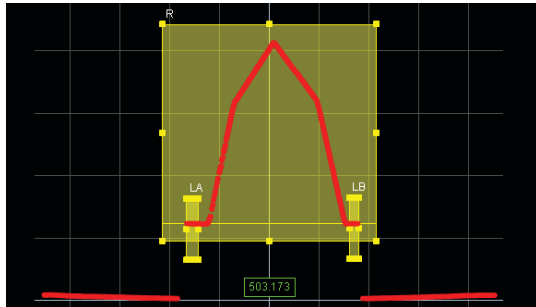

To create or edit an Intersect Area measurement:

- 1 Add a new Intersect Area measurement or select an existing Intersect Area measurement.**
- 2 Select the measurement Source.**  
Choices that are available depend on the system layout.
- 3 Adjust the measurement region.**  
The measurement region defines the zone in which cross-sectional area will be determined.
- 4 Adjust the fit line area(s).**  
An Intersect Area measurement uses a fit line to provide a baseline for the measurement region. One or two fit areas can be used for each fit line. Refer to Fit Lines (page 87) for more information.
- 5 Select object or clearance Area Type.**  
Object area is the area of regions above the baseline, regions below the baseline are ignored.  
Clearance area is the area of regions below baseline (ie between profile and line), regions above the baseline are ignored.
- 6 Provide minimum and maximum constraints for a decision.**  
Refer to Decisions (page 77) for more information on decisions.

## Box Area

A Box Area measurement determines the cross-sectional area within a region. The measurement value can be compared with minimum and maximum constraints to yield a decision.

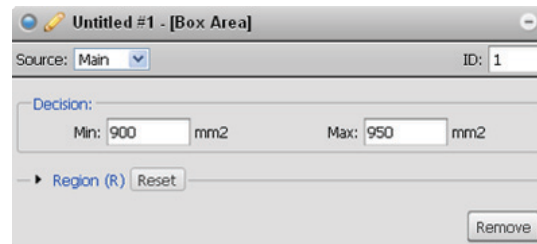

Areas are positive in regions where the profile is above the x-axis. In contrast, areas are negative in regions where the profile is below the x-axis.

*To create or edit a Box Area measurement:*

- 1 Add a new Box Area measurement or select an existing Box Area measurement.**
- 2 Select the measurement Source.**  
Choices that are available depend on the system layout.
- 3 Adjust the measurement region.**  
The measurement region defines the zone in which cross-sectional area will be determined.
- 4 Provide minimum and maximum constraints for a decision.**  
Refer to Decisions (page 77) for more information on decisions.

## Difference Area

A Difference Area measurement determines the difference in cross-sectional area between a live profile and template. The measurement value can be compared with minimum and maximum constraints to yield a decision.

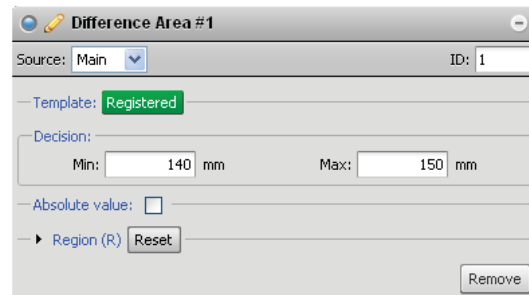
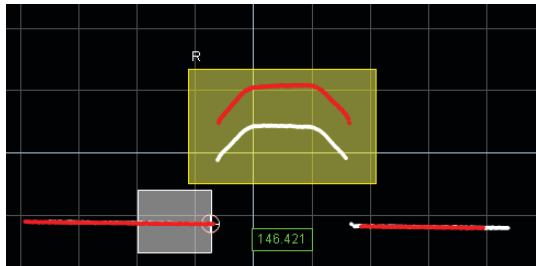

Area can be calculated as an absolute or signed value. Signed results are positive in regions where the live profile is closer to the sensors than the template. The illustrations below indicate the region where the results are positive and negative.

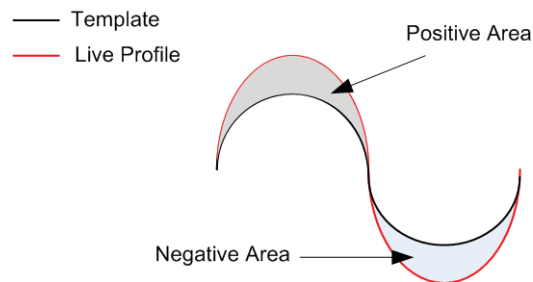

The result is the sum of all the areas within the measurement region.

*To create or edit a Difference Area measurement:*

**1 Add a new Difference Area measurement or select an existing Difference Area measurement.**

**2 Select the measurement Source.**

Choices that are available depend on the system layout. When both the Main sensor and the Buddy sensor are selected in opposite orientation, the calculation is applied to the thickness profiles of the live and template data. A thickness profile is calculated by subtracting the profile of the bottom sensor (i.e. the Buddy sensor) from the profile of the top sensor (i.e. the Main sensor).

**3 Adjust the measurement region.**

The measurement region defines the zone in which cross-sectional area will be determined.

**4 Select absolute or signed result.**

Check the Absolute box to select absolute result.

**5 Provide minimum and maximum constraints for a decision.**

Refer to Decisions (page 77) for more information on decisions.

## Difference Peak

A Difference Peak measurement determines the maximum difference in height between a live profile and the template. The measurement value can be compared with minimum and maximum constraints to yield a decision.

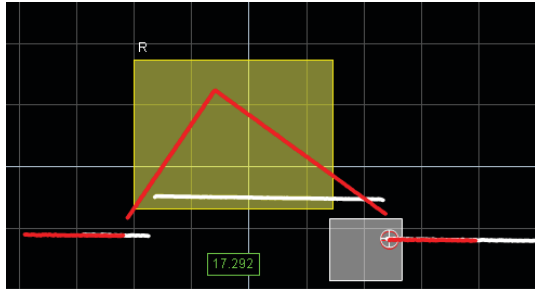

The difference in peak can be calculated as an absolute or signed value. A signed difference is positive in regions where the live profile is closer to the sensors than the template. The illustrations below indicate the region where the results are positive or negative.

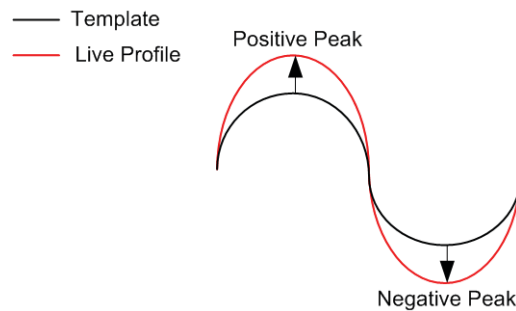

The result is the peak with the largest absolute value within region.

*To create or edit a Difference Peak measurement:*

**1 Add a new Difference Peak measurement or select an existing Difference Peak measurement.**

**2 Select the measurement Source.**

Choices that are available depend on the system layout. When both the Main sensor and the Buddy sensor are selected in opposite orientation, the calculation is applied to the thickness profiles of the live and template data. A thickness profile is calculated by subtracting the profile of the bottom sensor (i.e. the Buddy sensor) from the profile of the top sensor (i.e. the Main sensor).

**3 Adjust the measurement region.**

The measurement region defines the zone in which cross-sectional area will be determined.

**4 Select absolute or signed result.**

Check the Absolute box to select absolute result.

**5 Provide minimum and maximum constraints for a decision.**

Refer to Decisions (page 77) for more information on decisions.

## Script

A Script measurement can be used to program a custom measurement using a simplified C based syntax. A script measurement can produce a measurement value and a measurement decision.

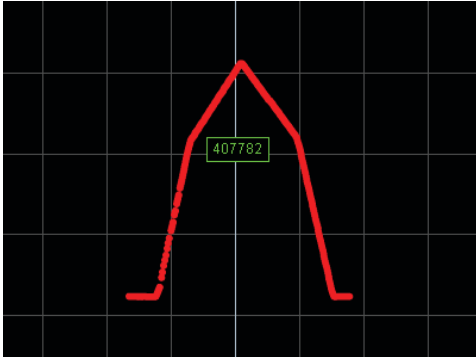

```
Untitled #1 - [Script]
ID: 1
Press save to store and apply script
1 char *name = "BoxArea";
2 signed long long BoxArea= -1;
3 if (exists(name))
4 {
5     BoxArea= value(name);
6 }
7 output (BoxArea, 1);
8
9
10
11
12
13
14
15
```

Refer to Script Measurement (page 80) for more information on the script syntax.

*To create or edit a Script measurement:*

### 1 Add a new Script measurement or select an existing Script measurement.

### 2 Edit the script code.

Build up your script by adding one line at a time. The script will be easier to debug if you begin with a few lines (e.g. `output(1, 1);`) and then build it up over a few iterations. Refer to the example below for script syntax.

### 3 Click the Save button to save the script code.

If there is a mistake in the script syntax, the result will be shown as a "0" with a red border in the Data Viewer when you run the sensor.

Outputs from multiple measurement tools can be used as inputs to the script. A typical script would take results from other measurement tools using the value and decision function, and output the result using the output function. Video and profile cannot be used as inputs to the script. Only one script can be created.

# Whole Part Measurement Tools

Whole part measurement involves capturing a sequence of laser profiles, identifying discrete objects, and measuring properties of those objects, such as volume or maximum height.

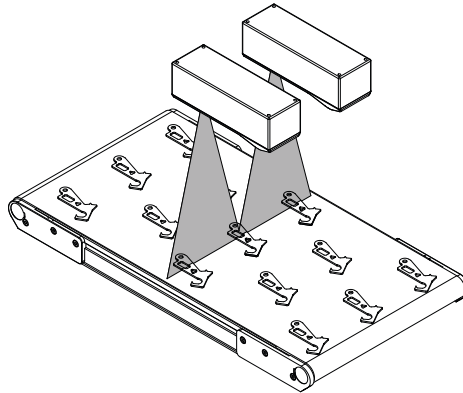

Multiple measurements can be performed on each part, limited only by the available CPU resources. The part measurement tools supported by Gocator sensors are summarized below.

---

Measurement	Examples
-------------	----------

<b>Area</b>	
-------------	--

Measures area in the XY plane.

Refer to Area (page 108).

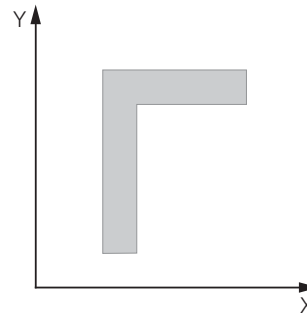

---

<b>Volume</b>	
---------------	--

Measures volume in XYZ space.

Refer to Volume (page 109).

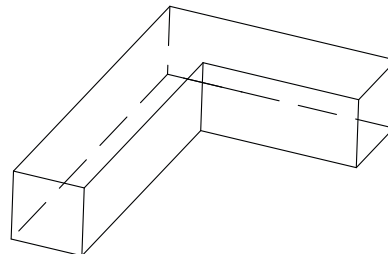

---

**Measurement****Examples**

---

**Height**

Measures maximum height, minimum height, or the height at the 2D centroid in the XY plane, or the 3D centroid in XYZ space.

Refer to Height (page 113).

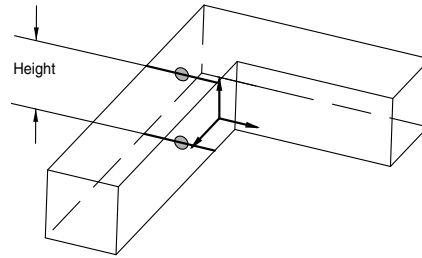
**Centroid X**

Measures the x-position of the part's 2D centroid in the XY plane, or the 3D centroid in XYZ space.

Refer to Centroid X (page 110).

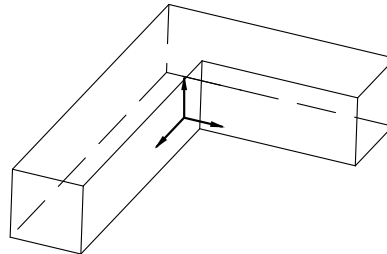
**Centroid Y**

Measures the y-position of the part's 2D centroid in the XY plane, or the 3D centroid in XYZ space.

Refer to Centroid Y (page 111).

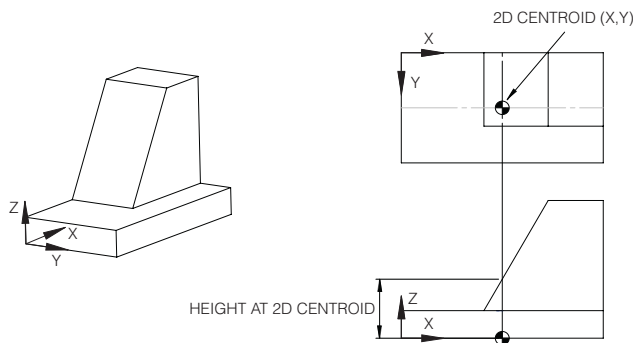
**Centroid Z**

Measures the z-position of the part's 2D centroid in the XY plane, or the 3D centroid in XYZ space.

Refer to Centroid Z (page 112).

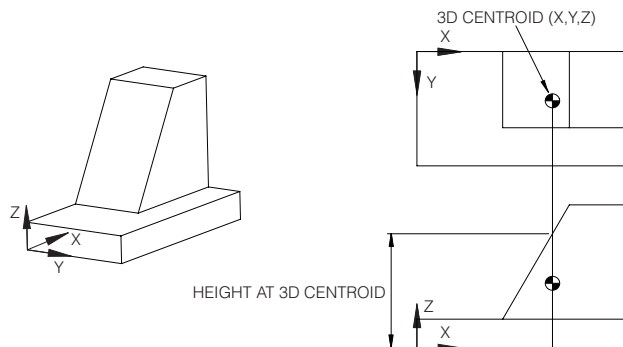
**Ellipse Major**

Measures the major axis length of an ellipse fitted to the part's shape in the XY plane.

Refer to Ellipse Major (page 116).

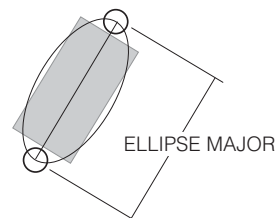

---

**Measurement****Examples**

---

**Ellipse Minor**

Measures the minor axis length of an ellipse fitted to the part's shape in the XY plane.

Refer to Ellipse Minor (page 115).

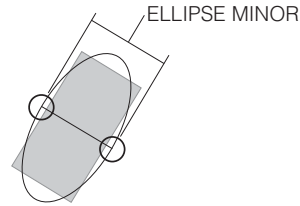
**Ellipse Ratio**

Measures the minor/major axis ratio of an ellipse fitted to the part.

Refer to Ellipse Ratio (page 117).

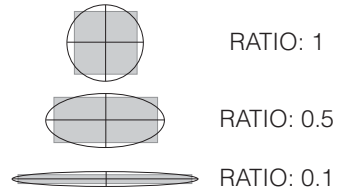
**Ellipse Angle**

Measures the orientation angle of an ellipse fitted to the part's shape in the XY plane.

Refer to Ellipse Angle (page 114).

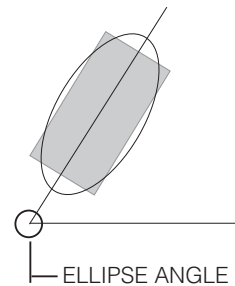
**Bounding Box X**

Measures the x-location of the corner of the smallest box that encapsulates the part.

Refer to Bounding Box X (page 118).

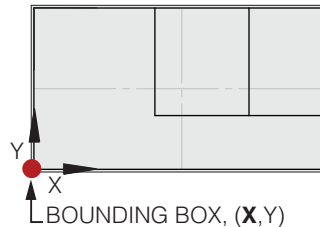
**Bounding Box Y**

Measures the y-location of the corner of the smallest box that encapsulates the part.

Refer to Bounding Box Y (page 119).

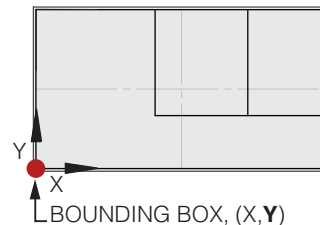
**Bounding Box Width**

Measures the width of the smallest box that encapsulates the part.

Refer to Bounding Box Width (page 120).

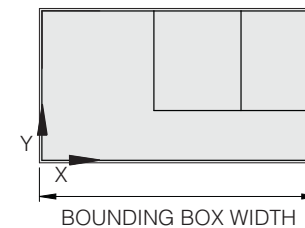

---

**Measurement****Examples**

---

**Bounding Box Length**

Measures the length of the smallest box that encapsulates the part.

Refer to Bounding Box Length (page 121).

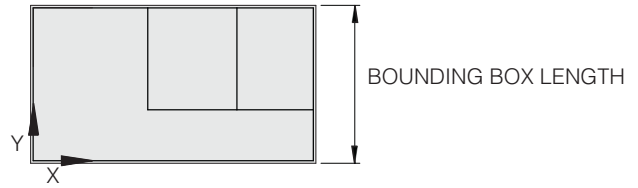

# Measurement Types

## Area

An Area measurement determines part area in the XY plane. The measurement value can be compared with minimum and maximum constraints to yield a decision.

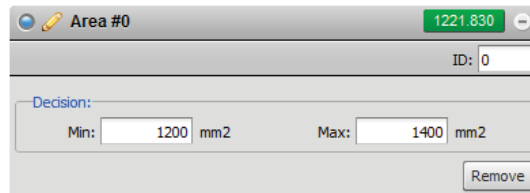

*To create or edit an Area measurement:*

- 1 Add a new Area measurement or select an existing Area measurement.**
- 2 Provide minimum and maximum constraints for a decision.**  
Refer to Decisions (page 77) for more information on decisions.

## Volume

A Volume measurement determines the volume of a part. The measurement value can be compared with minimum and maximum constraints to yield a decision.

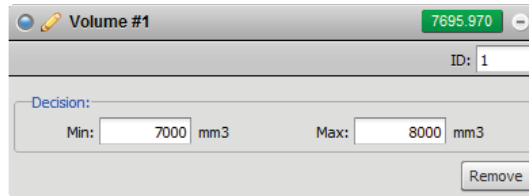

Volume #1 7695.970

ID: 1

Decision:

Min: 7000 mm3 Max: 8000 mm3

Remove

*To create or edit a Volume measurement:*

- 1 Add a new Volume measurement or select an existing Volume measurement.**
- 2 Provide minimum and maximum constraints for a decision.**  
Refer to Decisions (page 77) for more information on decisions.

## Centroid X

A Centroid X measurement determines the x-position of the 2D or 3D centroid of a part. The measurement value can be compared with minimum and maximum constraints to yield a decision.

The result is relative to the bounding box's x-position (page 240).

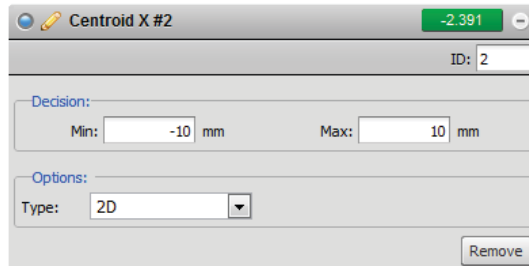

The image shows a software dialog box titled "Centroid X #2". In the top right corner, there is a green button with the value "-2.391". Below the title bar, there is a field for "ID:" with the value "2". The dialog is divided into two sections: "Decision:" and "Options:". Under "Decision:", there are two input fields: "Min:" with the value "-10 mm" and "Max:" with the value "10 mm". Under "Options:", there is a "Type:" dropdown menu currently set to "2D". A "Remove" button is located at the bottom right of the dialog.

*To create or edit a Centroid X measurement:*

**1 Add a new Centroid X measurement or select an existing Centroid X measurement.**

**2 Specify the centroid type.**

A 2D centroid uses part perimeter information to quickly estimate the center of the part in the XY plane. A 3D centroid uses all available profile information to compute the center of the part in XYZ coordinates.

**3 Provide minimum and maximum constraints for a decision.**

Refer to Decisions (page 77) for more information on decisions.

## Centroid Y

A Centroid Y measurement determines the y-position of the 2D or 3D centroid of a part. The measurement value can be compared with minimum and maximum constraints to yield a decision.

The y-coordinate is relative to the bounding box's y-position (page 114).

Part Centroid Y #3 100.116

ID: 3

Decision:

Min: 80 mm Max: 110 mm

Options:

Type: 2D

Remove

*To create or edit a Centroid Y measurement:*

**1 Add a new Centroid Y measurement or select an existing Centroid Y measurement.**

**2 Specify the centroid type.**

A 2D centroid uses part perimeter information to quickly estimate the center of the part in the XY plane. A 3D centroid uses all available profile information to compute the center of the part in XYZ coordinates.

**3 Provide minimum and maximum constraints for a decision.**

Refer to Decisions (page 77) for more information on decisions.

## Centroid Z

A Centroid Z measurement determines the z-position of the 2D or 3D centroid of a part. The measurement value can be compared with minimum and maximum constraints to yield a decision.

The z-position is relative to the sensor's system coordinate.

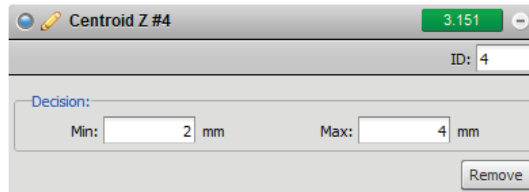

*To create or edit a Centroid Z measurement:*

**1 Add a new Centroid Z measurement or select an existing Centroid Z measurement.**

**2 Specify the centroid type.**

A 2D centroid uses part perimeter information to quickly estimate the center of the part in the XY plane. A 3D centroid uses all available profile information to compute the center of the part in XYZ coordinates.

**3 Provide minimum and maximum constraints for a decision.**

Refer to Decisions (page 77) for more information on decisions.

## Height

A Height measurement determines the height (thickness) of a part. The measurement value can be compared with minimum and maximum constraints to yield a decision.

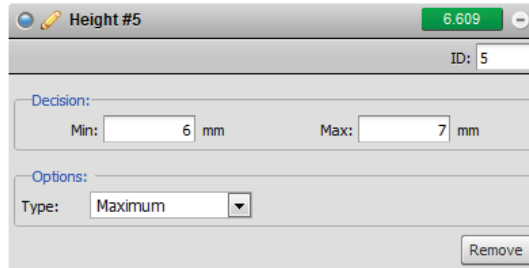

The screenshot shows a dialog box titled "Height #5" with a green status bar displaying "6.609". Below the title bar, there is an "ID: 5" field. The "Decision:" section contains two input fields: "Min: 6 mm" and "Max: 7 mm". The "Options:" section has a "Type:" dropdown menu set to "Maximum". A "Remove" button is located at the bottom right of the dialog.

*To create or edit a Height measurement:*

**1 Add a new Height measurement or select an existing Height measurement.**

**2 Specify the height type.**

The minimum height, maximum height or height of the part at the 2D or 3D centroid can be calculated. A 2D centroid uses part perimeter information to quickly estimate the center of the part in the XY plane. A 3D centroid uses all available profile information to compute the center of the part in XYZ coordinates.

**3 Provide minimum and maximum constraints for a decision.**

Refer to Decisions (page 77) for more information on decisions.

## Ellipse Angle

An Ellipse Angle measurement determines the orientation angle of an ellipse fitted to the part's area in the XY plane. The measurement value can be compared with minimum and maximum constraints to yield a decision.

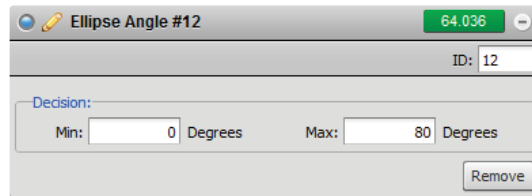

*To create or edit an Ellipse Angle measurement:*

**1 Add a new Ellipse Angle measurement or select an existing Ellipse Angle measurement.**

**2 Specify a reference angle for comparison.**

The result of the measurement is the difference between the ellipse orientation angle and the specified reference angle. Angles are measured counter-clockwise from the x-axis.

**3 Provide minimum and maximum constraints for a decision.**

Refer to Decisions (page 77) for more information on decisions.

## Ellipse Minor

An Ellipse Minor measurement determines the minor axis length of an ellipse fitted to the part's area in the XY plane. The measurement value can be compared with minimum and maximum constraints to yield a decision.

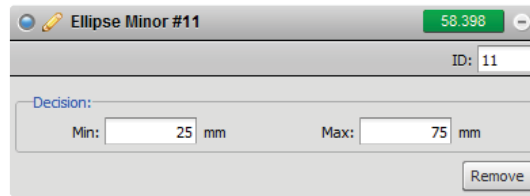

The screenshot shows a software dialog box titled "Ellipse Minor #11". In the top right corner, there is a green status bar displaying the value "58.398". Below the title bar, there is a field labeled "ID:" with the value "11". Underneath, a section labeled "Decision:" contains two input fields: "Min:" with the value "25" and "mm", and "Max:" with the value "75" and "mm". A "Remove" button is located at the bottom right of the dialog.

*To create or edit an Ellipse Minor measurement:*

- 1 Add a new Ellipse Minor measurement or select an existing Ellipse Minor measurement.**
- 2 Provide minimum and maximum constraints for a decision.**  
Refer to Decisions (page 77) for more information on decisions.

## Ellipse Major

An Ellipse Major measurement determines the major axis length of an ellipse fitted to the part's area in the XY plane. The measurement value can be compared with minimum and maximum constraints to yield a decision.

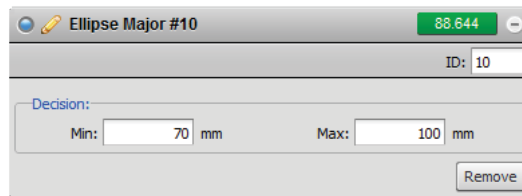

The screenshot shows a software dialog box titled "Ellipse Major #10". In the top right corner, there is a green box containing the value "88.644" and a minus sign. Below the title bar, there is a field labeled "ID:" with the value "10". Underneath, there is a section labeled "Decision:" containing two input fields: "Min:" with the value "70" and "mm", and "Max:" with the value "100" and "mm". A "Remove" button is located at the bottom right of the dialog box.

*To create or edit an Ellipse Major measurement:*

- 1 Add a new Ellipse Major measurement or select an existing Ellipse Major measurement.**
- 2 Provide minimum and maximum constraints for a decision.**  
Refer to Decisions (page 77) for more information on decisions.

## Ellipse Ratio

An Ellipse Ratio measurement determines the minor/major axis ratio of an ellipse fitted to the part's area in the XY plane. The measurement value can be compared with minimum and maximum constraints to yield a decision.

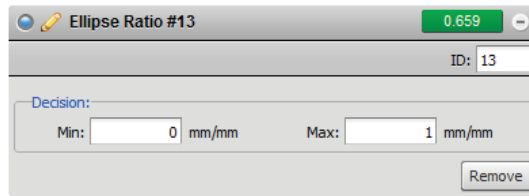

The axis ratio for a very elongated ellipse will be close to zero; the axis ratio for a nearly circular ellipse will be close to one.

*To create or edit an Ellipse Ratio measurement:*

- 1 Add a new Ellipse Ratio measurement or select an existing Ellipse Ratio measurement.**
- 2 Provide minimum and maximum constraints for a decision.**  
Refer to Decisions (page 77) for more information on decisions.

## Bounding Box X

A Bounding Box X measurement determines the lowest x-position of the smallest rectangle box that encapsulates the part. The measurement value can be compared with minimum and maximum constraints to yield a decision.

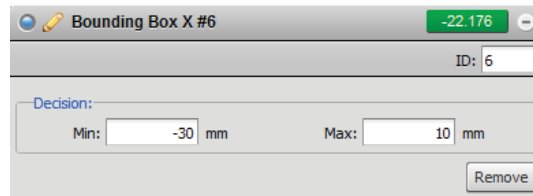

The image shows a software dialog box titled "Bounding Box X #6". In the top right corner, there is a green button with the value "-22.176" and a close icon. Below the title bar, there is a field labeled "ID:" with the value "6". Underneath, there is a section labeled "Decision:" containing two input fields: "Min:" with the value "-30 mm" and "Max:" with the value "10 mm". A "Remove" button is located at the bottom right of the dialog.

*To create or edit a Bounding Box X measurement:*

**1 Add a new Bounding Box X measurement or select an existing Bounding Box X measurement.**

**2 Provide minimum and maximum constraints for a decision.**

Refer to Decisions (page 77) for more information on decisions.

## Bounding Box Y

A Bounding Box Y measurement determines the lowest y-position of the smallest rectangle box that encapsulates the part.

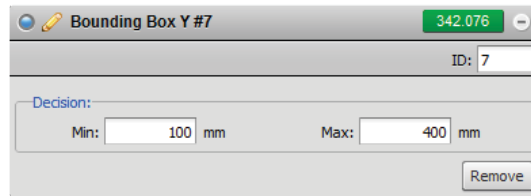

*To create or edit a Bounding Box Y measurement:*

- 1 Add a new Bounding Box Y measurement or select an existing Bounding Box Y measurement.**
- 2 Provide minimum and maximum constraints for a decision.**  
Refer to Decisions (page 77) for more information on decisions.

## Bounding Box Width

A Bounding Box Width measurement determines the width of the smallest rectangle box that encapsulates the part.

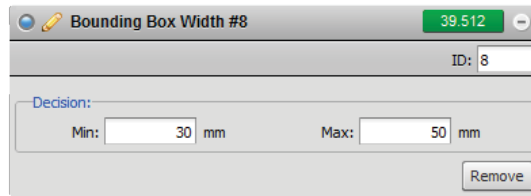

*To create or edit a Bounding Box Width measurement:*

**1 Add a new Bounding Box Width measurement or select an existing Bounding Box Width measurement.**

**2 Provide minimum and maximum constraints for a decision.**

Refer to Decisions (page 77) for more information on decisions.

## Bounding Box Length

A Bounding Box Length measurement determines the height (thickness) of the smallest rectangle box that encapsulates the part.

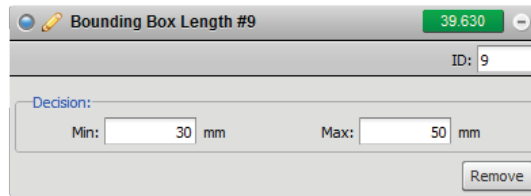

*To create or edit a Bounding Box Height measurement:*

**1 Add a new Bounding Box Length measurement or select an existing Bounding Box Length measurement.**

**2 Provide minimum and maximum constraints for a decision.**

Refer to Decisions (page 77) for more information on decisions.

## Script

Whole-part script measurements use the same syntax and functions as the profile script measurements. Refer to Script (page 103) section in the Profile Measurement chapter for more information.

# Output

## Output Page

Output configuration tasks are performed using the Output Page. Gocator sensors can transmit laser profiles and measurement results to a variety of external devices using a variety of output interface options.

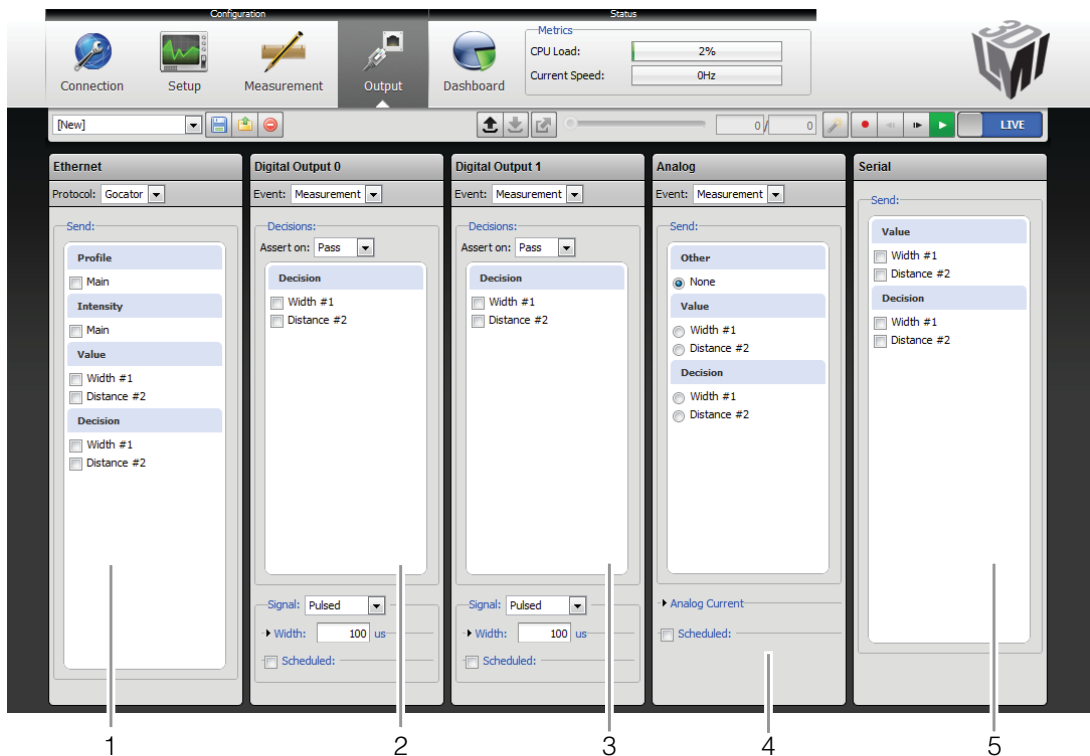

Element	Description
1	Ethernet Panel
2	Digital Output 0 Panel
3	Digital Output 1 Panel
4	Analog Panel
5	Serial Panel

# Ethernet Control and Output

A sensor uses TCP messages (Gocator Protocol) to exchange commands, video, laser profile, intensity and measurement results with client computers. The sensor can also exchange commands and measurement results with a PLC using Modbus TCP. Refer to Gocator Protocol (page 151) and Modbus TCP Protocol (page 199) for the specification of these protocols.

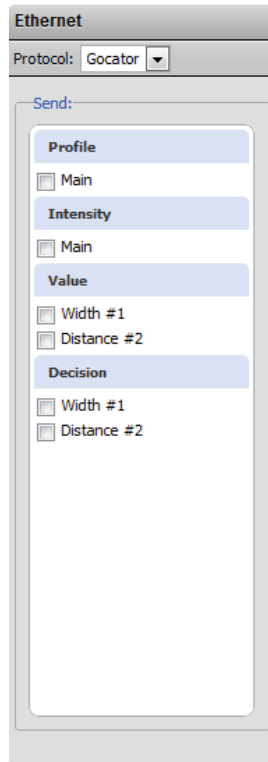

*To exchange results using Gocator Protocol messages:*

- 1 Navigate to the Ethernet panel.**
- 2 Select Gocator in the Protocol Option.**
- 3 Select the video, profile, intensity, decision value, or decision items to send.**

To select an item for transmission, place a check in the corresponding check box.

 Measurements shown here correspond to measurements that have been programmed using the Measurements Page.

All of the tasks that can be accomplished via the Gocator's web interface (configuration, calibration, receiving data, health information, and software triggering, etc.) can be accomplished programmatically by sending and receiving Gocator Protocol control commands. The sensor can process the control commands regardless of the selected protocol.

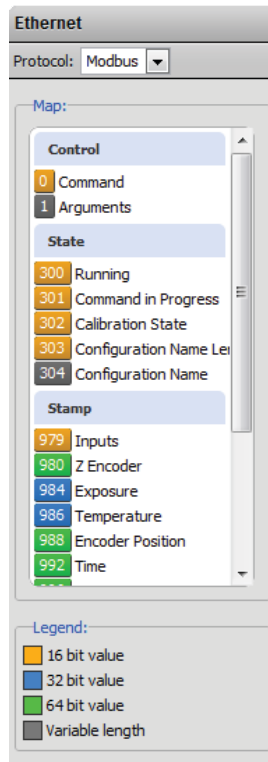

*To receive commands and send results using Modbus TCP messages:*

**1 Navigate to the Ethernet panel.**

**2 Select Modbus in the Protocol Option.**

Unlike using the Gocator Protocol, there is no need to select which measurement items to output. The Ethernet panel will list the register addresses that are used for Modbus TCP communication.

The Modbus TCP Protocol can be used to operate a sensor. Modbus TCP only supports a subset of the tasks that can be accomplished in the web interface. A sensor can only process Modbus TCP commands when the Modbus is selected in the protocol option.

# Digital Outputs

Gocator sensors can convert measurement decisions or software commands to digital output pulses, which can then be used to output to a PLC or to control external devices, such as indicator lights or air ejectors.

A digital output can also act as a measurement valid signal to allow external devices to synchronize to the timing at which measurement results are output. In this mode, the sensor outputs a digital pulse when a measurement result is ready.

Each sensor supports two digital output channels. Refer to Digital Outputs (page 227) for information on wiring digital outputs to external devices.



*To output measurement decisions:*

**1 Navigate to the Digital Output 0 or Digital 1 panel.**

**2 Set Event to Measurement**

**3 Select Assert Mode and decision sources that should be combined to determine the output.**

If multiple decision sources are selected and assert mode is set to pass, the output is activated when all selected measurement decisions pass. Conversely, if assert mode is set to false, the output is activated when any one of the selected measurement decisions is false.

**4 Specify a Signal type.**

The signal type specifies whether the digital output is a continuous signal or a pulsed signal. If the signal is continuous its state is maintained until the next transition occurs. If the signal is pulsed, the user specifies the pulse width and how it is scheduled.

## **5 Specify a Pulse Width.**

The pulse width is the duration of the digital output pulse, in microseconds.

## **6 Specify the output is Immediate or Scheduled.**

A pulsed digital output can be immediate or scheduled. Check the Scheduled option if the output needs to be scheduled.

A scheduled output becomes active after a specified delay from the start of Gocator exposure. A scheduled output can be used to track the decisions for multiple objects as these objects travel from the sensor to the eject gates. The delay specifies the distance from the sensor to the eject gates.

An Immediate output becomes active as soon as measurement results are available. The output activates after the sensor finishes processing the data. As a result, the time between the start of sensor exposure and output activates can vary and is dependent on the processing latency. The latency is reported in the dashboard and in the health messages.

## **7 Specify a Delay.**

The delay specifies the time or spatial location between the start of sensor exposure and when the output becomes active. The delay should be larger than the time needed to process the data inside the sensor. It should be set to a value that is larger than the processing latency reported in the dashboard or in the health messages.

The unit of the delay is configured in the trigger panel. Refer to Trigger (page 48) for details.

*To output a measurement valid signal:*

### **1 Navigate to the Digital Output 0 or Digital 1 panel.**

### **2 Set Event to Measurement.**

### **3 Set Assert On to Always.**

### **4 Select decision sources.**

The output activates when the selected decisions produce results. The output activate only once for each profile even if multiple decision sources are selected.

### **5 Specify a Pulse Width.**

The pulse width determines the duration of the digital output pulse, in microseconds.

*To respond to software scheduled commands:*

**1 Navigate to the Digital Output 0 or Digital 1 panel.**

**2 Set Event to Software.**

**3 Specify a Signal type.**

The signal type specifies whether the digital output is a continuous signal or a pulsed signal. If the signal is continuous, its state is maintained until the next transition occurs. If the signal is pulsed, user specifies the pulse width and the delay.

**4 Specify a Pulse Width.**

The pulse width determines the duration of the digital output pulse, in microseconds.

**5 Specify if the output is Immediate or Scheduled.**

A pulsed signal can become active immediately or scheduled. Continuous signal always becomes active immediately.

Immediate output becomes active as soon as a Scheduled Digital Output command (page 189) is received.

Scheduled output becomes active at a specific target time or position, given by the Scheduled Output command. The Delay setting in the panel is ignored. Commands that schedule event in the past will be ignored. An encoder value is in future if the value will be reached by moving in the forward direction (the direction that travel calibration was performed in).

# Analog Output

Gocator sensors can convert a measurement result or software request to an analog output. Each sensor supports one analog output channel.

Refer to Analog Output (page 229) for information on wiring analog output to an external device.

**Analog**

Event: Measurement

Send:

**Other**

None

**Value**

Width #1

Distance #2

**Decision**

Width #1

Distance #2

**Analog Current**

Data Scale: 0 - 10000

Current Range: 4 - 20 mA

Invalid: 0 mA

Scheduled: Delay: 0 ms

To output measurement value or decision:

**1 Navigate to the Analog panel.**

**2 Set Event to Measurement.**

**3 Select the value or decision source that should be used for output.**

Only one value or decision can be used for analog output. Measurements shown here correspond to measurements that have been programmed using the Measurements Page.

**4 Specify Data Scale values.**

The values specified here determine how measurement values are scaled to the minimum and maximum current output.

**5 Specify Current Range and Invalid current values.**

The values specified here determine the minimum and maximum current values in milliamperes. The invalid current value is used when a measurement value is not valid. If invalid is not checked, the output holds the last value when a measurement value is not valid.

## 6 Specify if the output is Immediate or Scheduled.

An analog output can become active immediately or scheduled. Check the Scheduled option if the output needs to be scheduled.

A scheduled output becomes active after a specified delay from the start of Gocator exposure. A scheduled output can be used to track the decisions for multiple objects as these objects travel from the sensor to the eject gates. The delay specifies the distance from the sensor to the eject gates.

An Immediate output becomes active as soon as the measurement results are available. The output activates after the Gocator finishes processing the data. As a result, the time between the start of Gocator exposure and output activates depends on the processing latency. The latency is reported in the dashboard and in the health messages.

## 7 Specify a Delay.

The delay specifies the time or spatial location between the start of Gocator exposure and the output becomes active. The delay should be larger than the time needed to process the data inside the Gocator. It should be set to a value that is larger than the processing latency reported in the dashboard and in the health messages.

The unit of the delay is configured in the trigger panel. Refer to Trigger (page 48) for details.

 The analog output takes about 75 us to reach 90% of the target value for a maximum change, then another ~40 us to settle completely.

*To respond to software scheduled commands:*

### 1 Navigate to the Analog panel.

### 2 Set Event to Software.

### 3 Specify if the output is Immediate or Scheduled.

An analog output value becomes active immediately or scheduled. Immediate output becomes active as soon as a Scheduled Analog Output command (page 240) is received.

Software scheduled command can schedule an analog value to output at a specified future time or encoder value, or changes its state immediately. The Delay setting in the panel is ignored. Commands that schedule event in the past will be ignored. An encoder value is in future if the value will be reached by moving in the forward direction (the direction that travel calibration was performed in).

# Serial Output

The Gocator's web interface can be used to select measurement values and decisions to be transmitted via RS-485 serial output. Each sensor has one serial output channel.

Refer to Serial Protocol (page 205) for serial connection parameters and data formats. Refer to Serial Output (page 229) for information on wiring serial output to an external device.

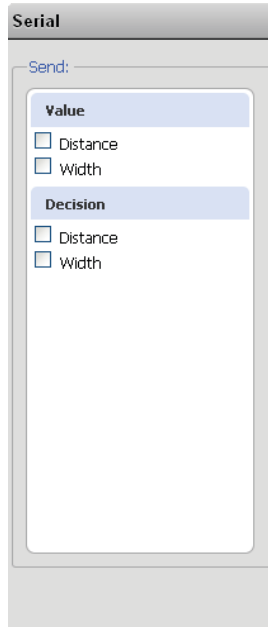

The screenshot shows a web interface panel titled "Serial". Below the title is a "Send:" label. The panel contains two sections: "Value" and "Decision". Each section has two checkboxes: "Distance" and "Width".

Section	Item	Selected
Value	Distance	<input type="checkbox"/>
	Width	<input type="checkbox"/>
Decision	Distance	<input type="checkbox"/>
	Width	<input type="checkbox"/>

*To configure serial output:*

## **1 Navigate to the Serial panel.**

## **2 Select the measurement value and decision items to send.**

To select an item for transmission, place a check in the corresponding check box. Measurements shown here correspond to measurements that have been programmed using the Measurements Page.

# Toolbar

The tool bar is the central place for performing common operations. This chapter explains how to use the toolbar to manage the sensor configurations and to operate the sensor.

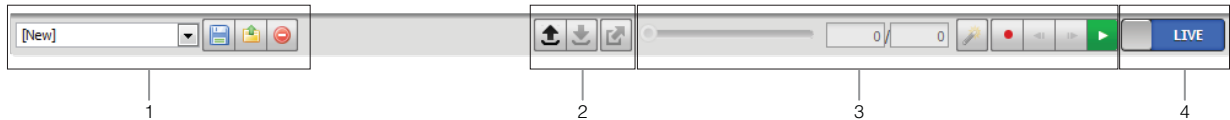

Element	Description
1	Configuration Controls Use the configuration controls to manage sensor settings.
2	Recorded Data Controls Use the recorded data controls to download, export and upload recorded data.
3	Sensor Operation / Replay Control Use the sensor operation controls to start sensors, enable recording and control recorded data.
4	Data Source Use the Data Source button to switch the sensor between live and replay mode.

# Saving and Loading Settings

When you change sensor settings using the Gocator web interface, some changes are saved automatically, while other changes are temporary until you take action to save them. The following table summarizes the types of information that can be saved in a sensor.

## Saved Information

Information Type	Behavior
Network Address	Network address changes are saved when you click the Save button in Main panel on the Connection Page. The sensor must be reset before changes take effect.
Configuration	Most of the settings that can be changed in the Gocator's web interface, such as those shown on Setup, Measurement, and Output pages, are temporary until saved in a <i>configuration</i> file. Each sensor can have multiple configuration files. If there is a configuration file that is designated as the <i>default</i> , it will be loaded automatically when the sensor is reset.
Calibration	<i>Calibration</i> files, described in Calibration (page 63), are saved automatically at the end of the calibration procedure. If a sensor contains a calibration file, it will automatically be loaded when the sensor is reset.
Profile Templates	<i>Profile templates</i> , described in Profile Fixturing (page 78), are temporary until saved. Each sensor can have multiple profile template files. If there is a template file that is designated as the <i>default</i> , it will be loaded automatically when the sensor is reset.

Each sensor can have, at most, one calibration record. But sensors can contain many configurations and template files – the number of files is limited only by the sensor's flash storage capacity.

Because configuration and profile template files are often used together to perform a particular task, the Gocator's web interface provides tool bar commands to load and save these files as a pair.

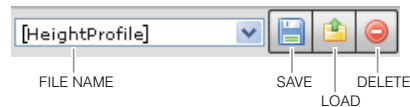

The File name drop down list shows the list of configuration and template pairs stored in the sensor. The configuration that is currently loaded will be listed at the top. The name will be marked with an asterisk if the live configuration is different from the loaded configuration to indicate unsaved changes.

To save a new pair of configuration and template files:

- 1 Select [New] in the File Name drop list.**
- 2 Enter a name for the file pair.**
- 3 Press the Enter key or click the Save button.**

The configuration and the template will be saved to flash memory using the name provided. The saved files will be set as the defaults to be loaded automatically when the sensor is reset.

*To overwrite an existing pair of configuration and template files:*

**1 Select an existing file name in the File Name drop list.**

**2 Click the Save button.**

A dialog will be prompted to confirm overwriting the existing files. The configuration and the template will be saved to flash memory using the selected name. The saved files will be set as the defaults to be loaded automatically when the sensor is reset.

*To load a pair of configuration and template files:*

**1 Select an existing file name in the File Name drop list.**

**2 Click the Load button.**

The configuration and the template are loaded from flash memory. Any unsaved changes to current settings will be overwritten when the files are loaded.

*To delete a pair of configuration and template files:*

**1 Select an existing file name in the File Name drop list.**

**2 Click the Delete button.**

The configuration and the template are deleted from the flash memory.

Managing individual files are described in the File Management (page 147) section.

# Managing Multiple Settings

A Gocator can store multiple sets of configurations and templates. This can be used when one set of equipment is used for different purposes or with different constraints during separate production runs. For example, width decision constraints might be loose during one production run and tight during another depending on the desired grade of the part.

*To manage a system with multiple configurations:*

**1 Configure settings for the first target object.**

Use the Setup, Measurement, and Output Pages to configure settings for the first target.

**2 Save the first configuration.**

Enter a file name and use the Save button to save the configuration.

**3 Configure settings for the second target object.**

Use the Setup, Measurement, and Output Pages to configure settings for the second target.

**4 Save the second configuration.**

Enter a file name (different from the one used for the first configuration) and use the Save button to save the configuration

**5 When production changes, load the desired configuration.**

Select the desired configuration and click the Load button. The configuration will be loaded and the sensors will ready for production.

# Recording and Playback

Gocator sensors have the ability to record and replay data. This feature is most often used for troubleshooting measurements, but can also be helpful during setup.

Recording and playback are controlled by using commands in the tool bar.

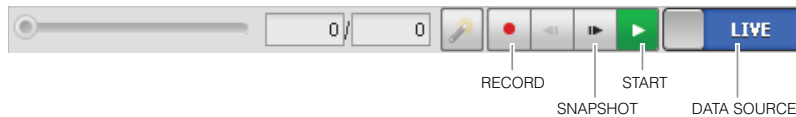

*Recording and Playback commands when Data Source is Live*



*Recording and Playback commands when Data Source is Replay*

*To record live data:*

## 1 Toggle the Data Source to Live.

## 2 Press the Record button.

When the Data Source is set to Live and recording is enabled, the sensor will store the most recent data as it runs. Remember to disable recording if you no longer wish to record live data (press the Record button again to disable).

## 3 Press the Snapshot button or Start button.

Snapshot will cause a single frame to be recorded. The Start button will run the sensor continuously and all frames will be recorded, up to available memory. When the memory limit is reached, the oldest data will be discarded. New data is appended to the record buffer unless the configuration has changed.

 New record data is appended to existing replay data unless the sensor configuration has been modified.

*To replay recorded data:*

## 1 Toggle the Data Source to Replay.

## 2 Use the Replay Slider, Step Forward, Step Back, or Play buttons to review data.

The Step buttons advance / reverse the current replay location by a single frame. The Play button advances the replay location continuously, animating the playback. The Pause button (replaces the Play button while playing) can be used to pause the replay at a particular location. The Replay slider (or Replay Position box) can be used to navigate to a specific replay frame.

*To clear recorded data:*

## 1 Toggle the Data Source to Replay.

## 2 Press the Clear Replay button.

# Downloading, Exporting and Uploading Recorded Data

Recorded data can be downloaded or exported to the client computer or uploaded to the Gocator. Export is often used for processing the recorded data using 3rd party tools. Recorded data can also be downloaded in a binary format. It is used to backup the data for reviewing in the future.

 Recorded data is not saved or loaded along with other files when you use the Save or Load commands in the Gocator's tool bar.

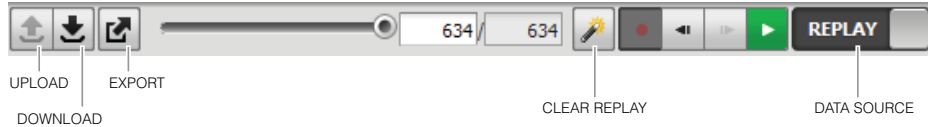

*To download recorded data:*

- 1 Toggle the Data Source to Replay.**
- 2 Press the Download button.**
- 3 Select the directory and file name to store on the client computer. Press OK.**

*To upload recorded data:*

- 1 Toggle the Data Source to Replay.**
- 2 Press the Upload button.**
- 3 Select the directory and the file name to load from the client computer. Press OK.**

Recorded profile, part and measurement data can be exported to CSV format. Recorded data can be exported by using the export command in the Gocator tool bar in replay mode.



*To export recorded data to CSV:*

- 1 Toggle the Data Source to Replay.**
- 2 Press the Export button.**

Select Export Ranges as CSV. In Profile and Raw mode, all data in the record buffer is exported. In Part Mode, only data in the current replay location is exported. Use the step button to move to a different replay location (page 136).
- 3 Select the directory and file name to store on the client computer. Press OK.**

Similarly, recorded intensity data can be exported to BMP format.

*To export recorded intensity data to BMP:*

**1 Toggle the Data Source to Replay.**

**2 Press the Export To BMP button.**

Select Export Intensity as BMP. Only the intensity data in the current replay location is exported. Use the step button to move to a different replay location.

**3 Select the directory and file name to store on the client computer. Press OK.**

# Dashboard

## Dashboard Page

The Dashboard Page summarizes logged events, sensor health information, and measurement statistics.

1

2

3

Measurements	Latest Value	Min/Max	Pass/Fail
Width #0	62.16	60.96/79.8	1726/1050
Height #1	-0.621	-3.576/2.28	73/2703

Element	Description
1	State and Health Information Displays sensor state and health information.
2	Measurement Statistics Displays measurement statistics.
3	Metric Panel Summarizes important performance statistics.

# State and Health Information

The following state and health information is available on the Dashboard:

## *Dashboard Health Values*

<b>Name</b>	<b>Description</b>
System State	Current system state (Ready or Running).
Speed	Current laser/camera speed (Hz).
Firmware Version	Gocator firmware version.
Interface Version	Gocator interface version.
Up Time	Length of time since the sensor was power-cycled or reset.
Encoder Value	Current encoder value (ticks).
Encoder Frequency	Current encoder frequency (Hz).
Trigger Drops	Count of camera frames dropped due to excessive trigger speed.
CPU Usage	Sensor CPU utilization (%).
Memory Usage	Sensor memory utilization (MB).
Memory Capacity	Sensor memory capacity (MB).
Storage Usage	Sensor flash storage utilization (MB).
Storage Capacity	Sensor flash storage capacity (MB).
Temperature	Sensor internal temperature (C).
Ethernet Traffic	Network output utilization (Bytes/sec).
Camera Drops	Count of frame drops due to camera errors.
Processing Drops	Count of frame drops due to excessive CPU utilization.
Ethernet Drops	Count of frame drops due to slow Ethernet link.
Processing Latency	Last delay from camera exposure to when results can be scheduled to.
Max Processing Latency	Latency Maximum delay from camera exposure to when results can be scheduled to Rich I/O. Reset on start.
Valid Point Count	Count of valid spots detected in the last frame.
Part Count	Count of discrete parts.

# Measurement Statistics

Statistics are displayed for each measurement that has been configured on the Measurement Page. The following information is available for each measurement:

## *Dashboard Measurement Statistics*

<b>Name</b>	<b>Description</b>
Latest Value	The most recent measurement value.
Minimum/Maximum Value	The minimum and maximum measurement values that have been observed.
Pass/Fail Count	The count of pass or fail decisions that have been generated.

# Metric Panel

Metric panel displays two important performance statistics in real-time: CPU Load and Current Frame Rate (Speed).

The CPU Load bar in the Metric panel (at the top of the interface) displays how much of the CPU is being utilized. A warning will appear if the sensor drops profiles because CPU is over utilized.

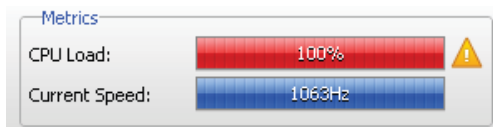

The Speed bar displays the frame rate of the sensor. A warning will appear if triggers (external input or encoder) are dropped because the external rate exceeds the maximum frame rate.

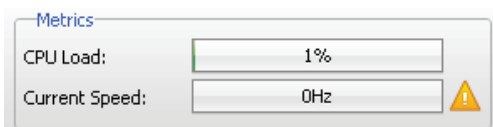

When a warning appears, click on the warning sign to reveal notifications that display more detailed information.

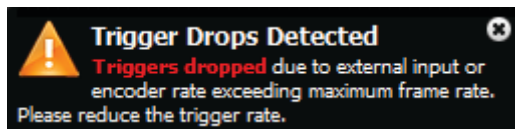

# Connection and Maintenance

## Connection Page

Gocator's security, file management and maintenance tasks are performed on the Connection Page.

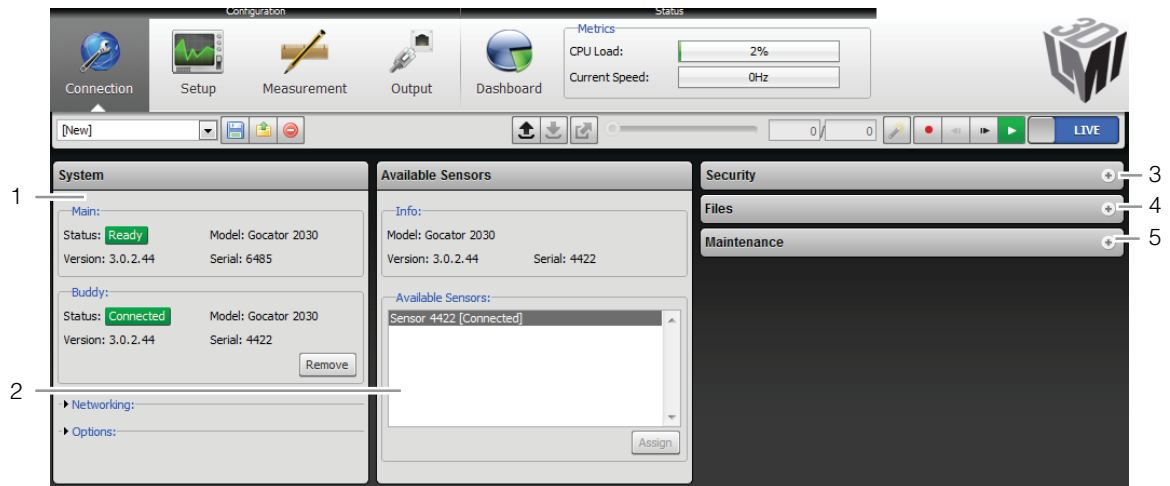

Element	Description
1	System Panel Use the System panel to configure sensor network and boot-up settings.
2	Available Sensor Panel Use the Available Sensor panel to assign or unassign Buddy sensors.
3	Security Panel Use the Security panel to change passwords.
4	Files Panel Use the Files panel to manage files stored on the main sensor.
5	Maintenance Panel Use the Maintenance panel to upgrade firmware, create/restore backups or reset sensors.

# Network Settings

The network settings need to be configured to match the network to which the Gocator sensors are connected.

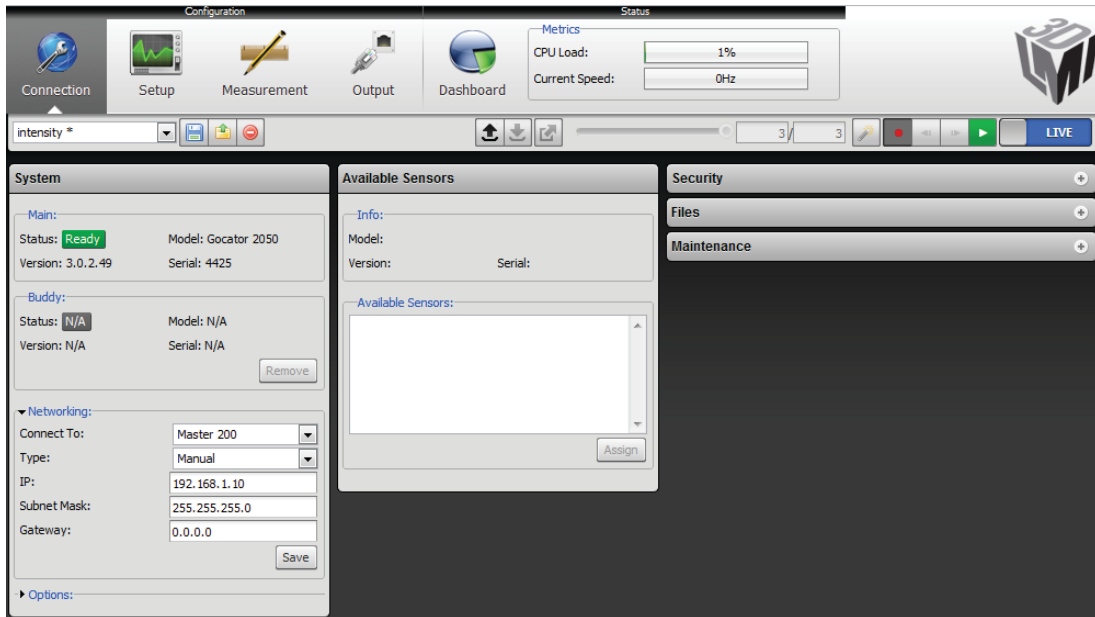

To configure the network settings:

- 1 Navigate to the System panel.**

Click the arrow next to Networking to expand the panel.

- 2 Specify the Connect To setting.**

The Connect To setting specifies whether the sensor system is standalone or connected to a Master.

- 3 Specify the Type, IP, Subnet Mask and Gateway settings.**

The Gocator sensor can be configured to use DHCP, or assigned a static IP address.

- 4 Click Save.**

When you click the Save button, you will be prompted to confirm your selection.

- 5 Reset or power-cycle the sensor.**

After changing network settings, the sensor must be reset or power-cycled before the change will take effect.

The Reset Sensor button in the Maintenance panel (page 142) can be used to perform a software reset.

# Auto Starting Sensors

With the Autostart setting enabled, laser profiling and measurement functions will begin automatically when the sensor is powered on. This setting is necessary when the sensor will be used without a computer connected.

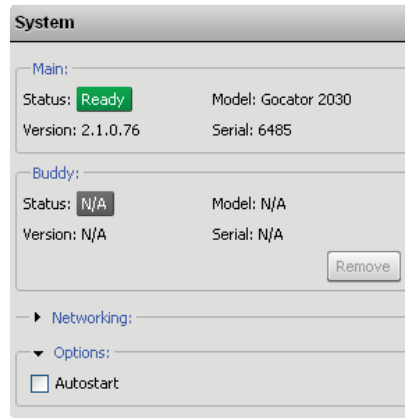

*To enable/disable Autostart:*

- 1 Check/Uncheck Autostart option box.**
- 2 Save configuration.**

# Buddy Assignment

In a dual sensor system, the Main sensor assumes control of the Buddy sensor after the Buddy sensor is assigned to the Main sensor. Configuration for both sensors can be performed through the Main sensor's interface.

- Main and Buddy sensors must be assigned unique IP addresses before they can be used on the same network. Before proceeding, connect the Main and Buddy sensors one at a time (to avoid an address conflict) and use the steps outline in Running a Dual Sensor System (page 32) to assign each sensor a unique address.

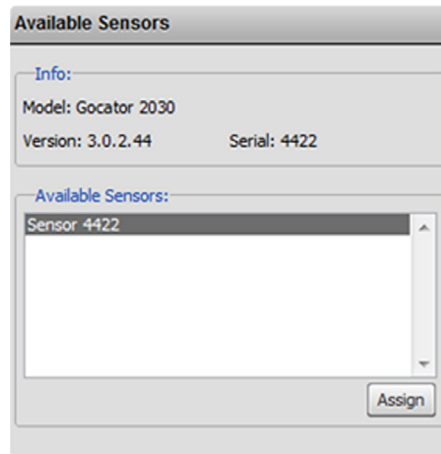

To assign a Buddy sensor:

## 1 Navigate to the Available Sensors panel.

## 2 Select a Buddy sensor.

The firmware on Main and Buddy sensors must be the same for Buddy assignment to be successful. If the firmware is different, connect the Main and Buddy sensor one at a time.

## 3 Click Assign.

The Buddy sensor will be assigned to the Main sensor and its status will be updated in the System panel.

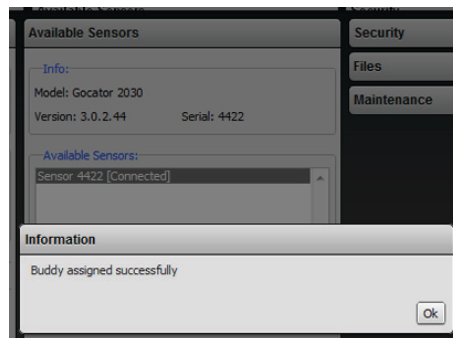

# Security

Gocator sensors can be secured with passwords to prevent unauthorized access. Each sensor has two accounts: Administrator and Technician.

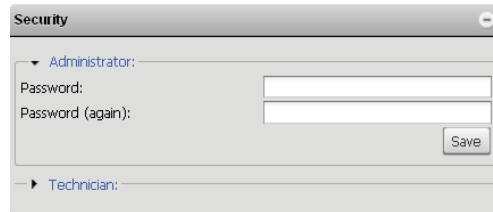

## *Gocator Account Types*

Account	Description
Administrator	The Administrator account has privileges to view and edit all settings, and to perform setup procedures such as sensor calibration.
Technician	The Technician account has privileges to view the Dashboard Page and to Start or Stop the sensor.

The Administrator and Technician accounts can be assigned unique passwords. By default, passwords are blank (empty).

*To set or change the password for the Administrator account:*

**1 Navigate to the Security panel.**

Click the arrow next to Administrator to expand the panel.

**2 Enter the new Administrator account password and password confirmation.**

**3 Click Save.**

The new password will be required the next time that an administrator logs in to the sensor.

*To set or change the password for the Technician account:*

**1 Navigate to the Security panel.**

Click the arrow next to Technician to expand the panel.

**2 Enter the new Technician account password and password confirmation.**

**3 Click Save.**

The new password will be required the next time that a technician logs in to the sensor.

If the administrator or technician password is misplaced, the sensor can be recovered using a special software tool. Refer to Recovery (page 150) for more information.

# File Management

The Files panel can be used to manage configurations and templates.

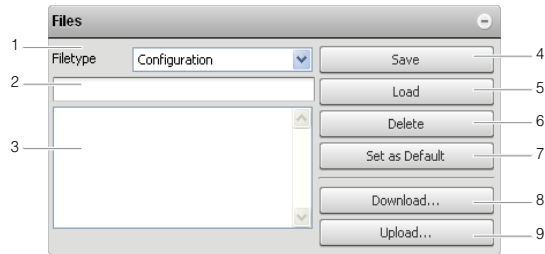

Element	Description	
1	File Type	Specifies the type of files to manage (Configuration, Profile Template, Replay Data).
2	File Name Field	Used to provide a file name when saving files.
3	File List	Displays the files that are currently saved in the sensor's flash storage.
4	Save Button	Saves currently loaded data to file using the name in the File Name Field.
5	Load Button	Loads the file that is selected in the File List.
6	Delete Button	Deletes the file that is selected in the File List.
7	Set as Default Button	Sets the selected file as the default to be loaded at boot time.
8	Download Button	Downloads the selected file to the client computer.
9	Upload Button	Uploads a file from the client computer.

The following types of files can be saved and loaded:

## File types

File Type	Description
Configuration	Contains the settings specified in the Setup, Measurement, and Output Pages.
Profile Template	Contains profile template data used for profile fixturing.

To manage a configuration or template file:

### 1 Navigate to Files panel.

### 2 Select the File Type.

### 3 Select the file in the File list.

To save the live configuration or template to a file, type in a new file name or select a file to replace with.

### 4 Select the action.

# Backup and Restore

The Maintenance panel can be used to create sensor backups, restore from a backup, or restore to factory defaults.

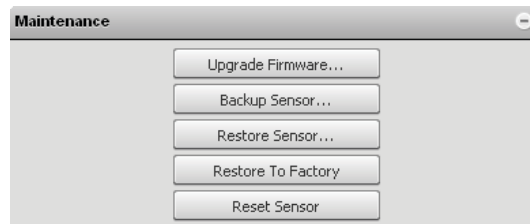

Backup files contain all of the information stored on board a sensor, including configuration, calibration, template, and replay files.

 It is recommended that Administrators create a backup file in the unlikely event that a sensor fails and a replacement sensor is needed. In such an event, the new sensor can be restored with the backup file.

*To create a backup:*

- 1 Navigate to the Maintenance panel.**
- 2 Click the Backup Sensor... button.**
- 3 When prompted, specify a location to save the backup.**

The backup will be saved to the specified location on the client computer. Backups are saved as a single archive that contains all of the files from the sensor.

*To restore from a backup:*

- 1 Navigate to the Maintenance panel.**
- 2 Click the Restore Sensor... button.**
- 3 When prompted, select a backup file to restore.**

The backup file will be uploaded and then used to restore the sensor. Any files that were on the sensor before the restore operation will be lost.

*To restore a sensor to its factory default settings:*

- 1 Navigate to the Maintenance panel.**
- 2 Consider making a backup.**
- 3 Click the Restore to Factory button.**
- 4 Reset the sensor.**

After restoring factory defaults, it is necessary to reset the sensor before the changes will take effect. Use the Reset Sensor button or cycle the power to affect a reset.

# Firmware Upgrade

LMI recommends routinely updating firmware to ensure that Gocator sensors always have the latest features and fixes.

 In order for the Main and Buddy sensors to work together, they must be use the same firmware version. This can be achieved by performing an upgrade through the Main sensor, or upgrading each sensor individually.

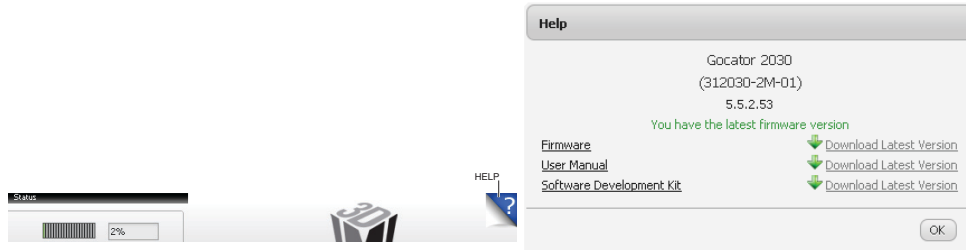

*To download the latest firmware:*

## 1 Click on the Help Link.

Ensure that the client computer is connected to the Internet.

## 2 Determine if an update is required.

The Help panel will check the LMI website to determine if the sensor's firmware is up to date.

## 3 Download the latest firmware.

If sensor firmware is not up to date, click the Firmware Link to visit the LMI website and then download the latest firmware.

If the client computer is not connected to the Internet, firmware can be downloaded and transferred to the client computer by using another computer to download the firmware from the LMI Technologies website: <http://www.lmi3d.com/support/downloads>

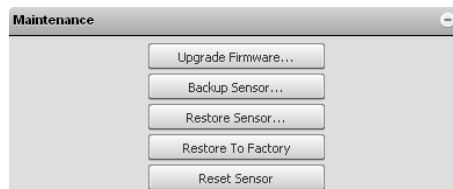

*To upgrade the firmware*

## 1 Navigate to the Maintenance panel.

## 2 Click the Update Firmware button.

## 3 Provide the location of the firmware file in the File dialog.

## 4 Wait for the upgrade to complete.

After the firmware upgrade is complete, the sensor will self-reset. If a buddy has been assigned, it will be automatically upgraded and reset along with the Main sensor.

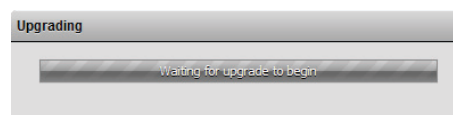

# Recovery

## Sensor Recovery Tool

If a sensor's network address or administrator password is forgotten, the sensor can be discovered on the network and/or restored to factory defaults by using a special software tool called the Sensor Discovery tool. This software tool can be obtained from the downloads area of LMI's website at <http://www.lmi3d.com>.

After downloading the tool package [14405-x.x.x.x\_software\_go2\_tools.zip], unzip the file and run the Sensor Discovery Tool [bin>win32>kDiscovery.exe].

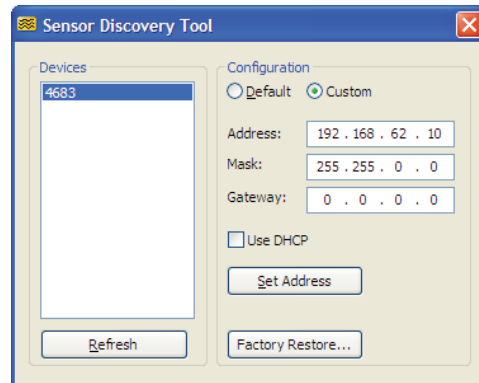

Any sensors that are discovered on the network will be displayed in the Devices list.

*To change the network address of a sensor:*

- 1 Select the sensor serial number in the Devices list.**
- 2 Select the Custom option.**
- 3 Enter the new network address information.**
- 4 Press the Set Address button.**

*To restore a sensor to factory defaults:*

- 1 Select the sensor serial number in the Devices list.**
- 2 Press the Factory Restore... button.**

Confirm when prompted.

 The Sensor Discovery tool uses UDP broadcast messages to reach sensors on different subnets. This enables the Sensor Discovery tool to locate and re-configure sensors even when the sensor IP address or subnet configuration is unknown.

# Gocator Protocol

This chapter describes TCP and UDP commands and data formats used by a client computer to communicate with Gocator sensors. Network communication enables the client to:

- Discover Main and Buddy sensors on an IP network and re-configure their network addresses.
- Configure Main and Buddy sensors.
- Send commands to run sensors, provide software triggers, read/write files, etc.
- Receive data, health, and diagnostic messages.
- Upgrade firmware.

The Concepts section in this chapter defines network connection types (Discovery, Control, Upgrade, Data, Health), common data types, and other terminologies. Subsequent sections provide details about network commands and data formats.

 The Gocator 2000 SDK provides open-source C language libraries that implement the network commands and data formats defined in this chapter. For more information, refer to Software Development Kit (page 208).

# Concepts

## Discovery

Sensors ship with the following default network configuration:

Setting	Default
DHCP	0 (disabled)
IP Address	192.168.1.10
Subnet Mask	255.255.255.0
Gateway	0.0.0.0 (disabled)

The Get Address and Set Address discovery commands can be used to modify a sensor's network configuration. Discovery commands are UDP broadcast messages:

Destination Address	Destination Port
255.255.255.255	3220

When a sensor accepts a discovery command, it will send an UDP broadcast response:

Destination Address	Destination Port
255.255.255.255	Port of command sender.

The use of UDP broadcasts for discovery enables a client computer to locate a sensor when the sensor and client are configured for different subnets. All you need to know is the serial number of the sensor in order to locate it on an IP network.

## Command Channels

A client can send commands and receive responses over the Control and Upgrade TCP channels.

### *Command Channels*

Channel	Port	Description
Control	3190	Sensor accepts commands for most operations.
Upgrade	3192	Sensor accepts commands for firmware upgrades.

The Control and Upgrade channels can be connected simultaneously, but the sensor will accept only a single connection on each port. If an additional connection is attempted on a port that is already connected, the previous connection will be closed and the new connection will be accepted.

## Result Channels

A client can receive data messages from a Gocator sensor by connecting to the Data or Health TCP channels.

### *Result Channels*

Channel	Port	Description
Data	3196	Sensor sends data messages.
Health	3194	Sensor sends health messages.

The above ports can be connected simultaneously and the sensor will also accept multiple connections on each port.

## Modes

A Gocator system can operate in the following modes.

### System Modes

Mode	Description
Video	Sends raw video.
AlignCalibrate	Performs alignment calibration.
TravelCalibrate	Performs travel calibration.
ExpCalibrate	Performs automatic exposure adjustment.
ProfileTemplate	Performs profile template registration.
ProfileMeasure	Performs profile measurements (default mode).
PartMeasure	Performs part detection and measurements.
Raw	Performs profiling and output raw profile data.

## Buddy Communication Channels

The peer-to-peer control channels are used by Gocator sensors to communicate amongst each other.

Channel	Port	Description
Discovery	2002, 2005, 2008	Gocator peer discovery port. UDP broadcasts on the subnet is sent once every second.
Command	2002 to 2015	Gocator request and response ports. Gocator uses UDP communications on these ports for configuration and reporting.
Data	2500	Main Gocator listens on this port for TCP traffic from the Buddy sensor. Buddy sensor communicates using a free port available at the time.

## States

A Gocator system can be in one of three states: Conflict, Ready, or Running. The Start and Stop commands are sent by the client to change the current state. The sensor can be configured to boot in either the Ready or Running state.

In the Ready state, a sensor can be configured. In the Running state, a sensor will respond to input signals, perform measurements, drive its outputs, and send data messages to the client.

The conflict state indicates that a sensor has been configured with a Buddy sensor but the Buddy sensor is not present on the network. The sensor will not accept some commands until the Change Buddy command is used to remove the configured Buddy.

The state of the sensor is not affected by connecting/disconnecting to command or result channels.

## Versions and Upgrades

Upon connection to a Gocator device, the *Get Protocol Version* and *Get System Info* commands can be used to establish protocol and firmware versions.

### Versions

Version	Description
Protocol version	Sensor protocol version (major, minor).
Firmware version	Sensor firmware version (major, minor, release, build).

The *protocol version* refers to the version of the Gocator Protocol supported by the *connected sensor* (the sensor to which a command connection is established), and consists of major and minor parts.

The minor part is updated when backward-compatible additions are made to the Gocator Protocol. The major part will be updated in the event that breaking changes are made to the Gocator Protocol.

The *firmware version* refers to the version of the Gocator's firmware installed on each individual sensor. The client can upgrade the Gocator's firmware by sending the Upgrade command. Firmware upgrade files are available from the downloads section under the support tab on the LMI web site. Refer to Firmware Upgrade (page 149) for more information on obtaining the latest firmware.

Every Gocator sensor contains factory backup firmware. Should a firmware upgrade command fail (e.g. power is interrupted), the factory backup firmware will be loaded when the sensor is reset or re-powered. In this case, the sensors will fall back to the factory default IP address. To avoid IP address conflicts in a multi-sensor system, connect to one sensor at a time and re-attempt the firmware upgrade.

## Data Types

The table below defines the data types and associated type identifiers used throughout this document. All values are transmitted in little endian format (least significant byte first) unless stated otherwise.

*Data Types*

Type	Id	Description
8u	1	8-bit unsigned integer.
8s	2	8-bit signed integer.
16u	3	16-bit unsigned integer.
16s	4	16-bit signed integer.
32u	5	32-bit unsigned integer.
32s	6	32-bit signed integer.
64u	7	64-bit unsigned integer.
64s	8	64-bit signed integer.
byte	9	1 Byte.
char	10	8-bit ASCII-encoded character.
64f	11	64-bit floating point value.
32f	12	32-bit floating point value.

 IP addresses are a notable exception to the little endian rule – the bytes in the address “a.b.c.d” will always be transmitted in the order a, b, c, d (big endian)..

## Profile Sources

Profile data is always associated with a *profile source*. The profile source identifies the scope and nature of the laser profile information.

*Profile Sources*

Profile Source	Id	Description
Main	0	Data from the Main sensor
Buddy	1	Data from the Buddy sensor
Combined	100	Combined data from the Main and Buddy sensor (for wide orientation)
Sensor	X	Data from an individual sensor, where X is the sensor serial number.

## Status Codes

Each reply on the Discovery, Control, and Upgrade channels contains a status code indicating the result of the command. The following status codes are defined.

### Status Codes

Label	Value	Description
OK	1	Command succeeded.
Failed	0	Command failed.
Invalid State	-1000	Command is not valid in the current state.
Item Not Found	-999	A required item (e.g. file) was not found.
Invalid Command	-998	Command is not recognized.
Invalid Parameter	-997	One or more command parameters are incorrect.
Not Supported	-996	The operation is not supported.

## Command and Reply Formats

Commands and replies that are sent and received on the Control and Upgrade channels each begin with a common header.

### Command Header

Field	Type	Description
length	64s	Command size, in bytes.
id	64s	Command identifier.

### Reply Header

Field	Type	Description
length	64s	Reply size, in bytes.
id	64s	Reply identifier (same as command identifier, unless otherwise noted).
status	64s	Reply status.

 Length fields prepended to the beginning of each message refer to the size of the entire message including the length field itself. For example, the value of the length field for a command that consists of only the header (no additional fields) would be 16.

## Result Format

*Result* messages that are received on the Data and Health channels have a common structure. Each result message has a flexible number of attributes in its header followed by a variable number of data blocks after the header. The structure of result messages is defined below.

### *Result*

Field	Type	Description
length	64s	Message length, in bytes.
id	64s	Message type identifier.
attributeCount	64s	Count of attributes in this message.
dataCount	64s	Count of data blocks in this message.
attributes[N]	64s	List of attributes specific to a particular message type.
descriptors[M]	Descriptor	List of data block descriptors (one per data block - format defined below).
blocks[M]	-	List of data blocks specific to a particular message type.

### *Block Descriptor*

Field	Type	Description
length0	64s	Length of block dimension 0.
length1	64s	Length of block dimension 1.
length2	64s	Length of block dimension 2.
type	Type	Data type of block elements - refer to Data Types (page 154).

Each data block is an array of primitive values with 1, 2, or 3 dimensions and is described by an accompanying descriptor. The first *length* field that contains a zero determines the dimensionality of the block. For example, the length 2 field will contain zero for a 2 dimensional block. Items in the highest numbered dimension are transmitted sequentially.

Specific result messages, described later in this chapter, are defined by identifying the attributes and data block formats necessary to express the message content.

# Configuration Files

Configuration XML files contain settings that govern system behavior in the Running state.

Elements contain three types of values: *settings*, *constraints*, and *properties*. Settings are input values that can be edited. Constraints are read-only limits that define the valid values for settings. Properties are read-only values that provide supplemental information related to sensor setup.

When a configuration file is received from a sensor, it will contain settings, constraints, and properties. When a configuration file is sent to a sensor, any constraints or properties in the file will be ignored.

Changing the value of a setting can potentially affect multiple constraints and properties. After uploading a configuration file, the configuration file can be downloaded again to access updated values.

## Setup

The Setup element contains settings related to system and sensor setup.

### Setup Child Elements

Element	Type	Description
StartupState	32s	Setting for the default state of the system at boot time: 0 – Ready. 1 – Running.
StartupMode	String	Setting for the default system mode at boot time.
XResamplingType	32s	Setting for the resampling interval: 0 – Maximum resolution 1 – Balanced 2 – Maximum speed
IntensityEnable	32u	Setting to disable or enable intensity output: 0 – Disable 1 – Enable
XResamplingInterval	64f	Property for x-resampling interval (mm).

## TRIGGER

The Trigger element contains settings related trigger source, speed, and encoder resolution.

### Trigger Child Elements

Element	Type	Description
TriggerSource	32s	Setting for trigger source: 0 – Time 1 – Encoder 2 – Input 3 – Software
SystemDomain	32s	Setting for units for trigger delay and output scheduling: (Ignored when TriggerSource is Time or Encoder.) 0 – Microseconds 1 – Millimeters
FrameRate	64f	Setting for frame rate (Hz) (Applicable for time-based triggering).
FullFrameRateEnable	32u	Setting to enable or disable full frame rate operation: 0 – Use FrameRate setting 1 – Ignore FrameRate setting, run at maximum frame rate

Element	Type	Description
EncoderTriggerMode	32s	Setting for the encoder behavior: 0 – Track Reverse 1 – Ignore Reverse 2 – Bi-directional
EncoderPeriod	64f	Setting for encoder period (mm). (Applicable for encoder-based triggering)
TriggerDelay	64f	Setting for trigger delay (us or mm).
GateEnable	32u	Setting to disable or enable the use of digital input to gate the time or encoder trigger source: 0 – Disable 1 – Enable
FrameRateMin	64f	Constraint for minimum frame rate (Hz).
FrameRateMax	64f	Constraint for maximum frame rate (Hz).
EncoderPeriodMin	64f	Constraint for minimum encoder period (ticks).
EncoderPeriodMax	64f	Constraint for maximum encoder period (ticks).
TriggerDelayMin	64f	Constraint for minimum trigger delay (us or ticks).
TriggerDelayMax	64f	Constraint for maximum trigger delay (us or ticks).

## LAYOUT

The Layout element contains settings related to the layout/orientation of the system.

### Layout Child Elements

Element	Type	Description
Orientation	32s	Setting for orientation type: 0 – Isolated 1 – Wide 3 – Opposite
Overlap	32s	Setting for overlap: 0 – No overlap 1 – Overlap
CalibratedX	64f	Property for system-calibrated active area X position (mm).
CalibratedZ	64f	Property for system-calibrated active area Z position (mm).
CalibratedWidth	64f	Property for system-calibrated active area width (mm).
CalibratedHeight	64f	Property for system-calibrated active area height (mm).

## CALIBRATION

The Calibration element contains settings related to alignment and travel calibration.

### Calibration Child Elements

Element	Type	Description
AlignmentTarget	32s	Setting for alignment calibration target type: 0 – None 1 – Bar
TravelTarget	32s	Setting for travel calibration target type: 1 – Bar 2 – Disk
Disk/Diameter	64f	Setting for diameter of calibration disk (mm).
Disk/Height	64f	Setting for thickness of calibration disk (mm).
Bar/Height	64f	Setting for height of calibration bar (mm).
Bar/Width	64f	Setting for width of calibration bar (mm).

Element	Type	Description
Bar/Holes	64f	Setting for number of holes on the calibration bar.
Bar/HoleDistance	64f	Setting for distance between calibration bar holes (mm).
Bar/HoleDiameter	64f	Setting for diameter of calibration bar holes (mm).

## FILTERS

The Filters element contains the settings related to post processing the profiles before they are output or used by measurement tools.

### Filters Child Elements

Element	Type	Description
XSmoothing\Enable	32u	Setting to enable or disable X Smoothing filter: 0 – Disable 1 – Enable
XSmoothing\Window	64f	Setting for X Smoothing filter window (mm).
XSmoothing\WindowMin	64f	Constraint for minimum window size (mm).
XSmoothing\WindowMax	64f	Constraint for maximum window size (mm).
YSmoothing\Enable	32u	Setting for enable or disable Y Smoothing filter: 0 – Disable 1 – Enable
YSmoothing\Window	64f	Setting for YSmoothing filter window (mm).
YSmoothing\WindowMin	64f	Minimum window size (mm).
YSmoothing\WindowMax	64f	Maximum window size (mm).
XGapFilling\Enable	32u	Setting to enable or disable X Gap Filling filter: 0 – Disable 1 – Enable
XGapFilling\Window	64f	Setting for X Gap Filling filter window (mm).
XGapFilling\WindowMin	64f	Constraint for minimum window size (mm).
XGapFilling\WindowMax	64f	Constraint for maximum window size (mm).
YGapFilling\Enable	32u	Setting for enable or disable Y Gap Filling filter: 0 – Disable 1 – Enable
YGapFilling\Window	64f	Setting for Y Gap Filling filter window (mm).
YGapFilling\WindowMin	64f	Minimum window size (mm).
YGapFilling\WindowMax	64f	Maximum window size (mm).

## SENSORS / SENSOR

Each Sensor element contains settings related to an individual sensor. A Sensor element has an attribute that defines the role (0 – Main, 1 – Buddy) of the sensor:

```
<Sensor role="0">
```

*Profiling Child Elements*

<b>Element</b>	<b>Type</b>	<b>Description</b>
ExposureMode	32u	Setting for exposure mode: 0 – Single exposure 1 – Multiple exposures 2 – Dynamic exposure
ExposureDelay	32u	Setting for an optional delay (us) between triggering event and the actual start of the exposure. This is used for time multiplexing the sensors in a multi-sensor system.
ExposureStep	Collection	Collection of exposure steps.
ExposureStep/Step	32u	Setting for exposure steps (us).
Exposure	32u	Setting for exposure (us).
DynamicExposureMax	32u	Setting for maximum exposure (for dynamic exposure).
DynamicExposureMin	32u	Setting for minimum exposure (for dynamic exposure).
ActiveAreaX	64f	Setting for active area X position (mm).
ActiveAreaZ	64f	Setting for active area clearance distance (mm).
ActiveAreaWidth	64f	Setting for active area field of view (mm).
ActiveAreaHeight	64f	Setting for active area measurement range (mm).
XResolution	32u	Setting for X resolution divider.
ZResolution	32u	Setting for Z resolution divider.
ExposureMin	32u	Constraint for minimum exposure (us).
ExposureMax	32u	Constraint for maximum exposure (us).
ActiveAreaXMin	64f	Constraint for minimum X field of view boundary (mm).
ActiveAreaXMax	64f	Constraint for maximum X field of view boundary (mm).
ActiveAreaZMax	64f	Constraint for maximum Z field of view boundary (mm).
ActiveAreaZMin	64f	Constraint for minimum Z field of view boundary (mm).
ActiveAreaWidthMin	64f	Constraint for minimum field of view width (mm).
ActiveAreaWidthMax	64f	Constraint for maximum field of view width (mm).
ActiveAreaHeightMin	64f	Constraint for minimum field of view height (mm).
ActiveAreaHeightMax	64f	Constraint for maximum field of view height (mm).
XResolutionOptions	String	Constraint for x resolution options – comma delimited list (e.g. "1,2").
ZResolutionOptions	String	Constraint for z resolution options – comma delimited list (e.g. "1,2").
CameraX	32u	Property for x position of image ROI (pixels).
CameraY	32u	Property for y position of image ROI (pixels).
CameraWidth	32u	Property for width of image ROI (pixels).
CameraHeight	32u	Property for height of image ROI (pixels).
CalibratedX	64f	Property for sensor calibrated active area X position (mm).
CalibratedZ	64f	Property for sensor calibrated active area Z position (mm).
CalibratedWidth	64f	Property for sensor calibrated active area width (mm).
CalibratedHeight	64f	Property for sensor calibrated active area height (mm).

## Profile

The Profile element contains settings that affect profile measurements. Simple child elements in Profile are defined below:

### *ProfileMeasurement Child Elements*

Element	Type	Description
MeasurementOptions	String	Constraint for available measurement types - comma delimited list (e.g. "Width, Distance").

The Profile element also contains two significant sub-elements: Anchor and Measurements. The Anchor element defines profile anchoring behavior, while the Measurements element contains one sub-element for each requested profile measurement.

The id attribute associated with each measurement defines an identifier that must be unique among all measurements in the configuration file.

e.g. <width id="1001">

Most profile measurement elements contain one or more Area, Feature or Line sub-elements. These common structures are described first.

## AREA

An Area element defines a rectangular area of interest.

### *Area Child Elements*

Element	Type	Description
X	64f	Setting for area x position (mm).
Z	64f	Setting for area z position (mm).
Width	64f	Setting for area width (mm).
Height	64f	Setting for area height (mm).

## FEATURE

A Feature element defines the settings for detecting a feature within an area of interest.

### *Feature Child Elements*

Element	Type	Description
Type	32s	Setting to determine how the feature is detected within the area: 0 – Top 1 – Bottom 2 – Right 3 – Left 4 – Corner 5 – Average 6 – Rising Edge 7 – Falling Edge 8 – Any Edge 9 – Top Corner 10 – Bottom Corner 11 – Left Corner 12 – Right Corner 13 – Median
Area	Area	Element for feature detection area.

## LINE

A Line element defines measurement areas used to calculate a line.

### Line Child Elements

Element	Type	Description
Area[2]	Area	2 area elements used for line fitting.

## ANCHOR

An anchor element defines settings for anchoring.

### Anchor Child Elements

Element	Type	Description
Enable	32s	Setting for enable or disable anchoring.
Type	32s	Setting to determine how the feature is detected within the area: 0 – Top 1 – Bottom 2 – Right 3 – Left 4 – Corner 5 – Average 6 – Rising Edge 7 – Falling Edge 8 – Any Edge 9 – Top Corner 10 – Bottom Corner 11 – Left Corner 12 – Right Corner 13 – Median
Area	Area	Area element used for anchoring.

## MEASUREMENTS / WIDTH

A Width element defines settings for a profile width measurement.

### Width Child Elements

Element	Type	Description
Name	String	Setting for measurement name.
Source	32s	Setting for profile source.
DecisionMin	64f	Setting for decision threshold minimum (mm).
DecisionMax	64f	Setting for decision threshold maximum (mm).
AbsoluteResult	32u	Setting for selecting absolute or signed result: 0 – Signed result 1 – Absolute result
Feature[2]	Feature	Elements for feature detection.
SourceOptions	String	Constraint for eligible profile sources (comma-delimited list).

## MEASUREMENTS / HEIGHT

A Height element defines settings for a profile height measurement.

#### Height Child Elements

Element	Type	Description
Name	String	Setting for measurement name.
Source	32s	Setting for profile source.
DecisionMin	64f	Setting for decision threshold minimum (mm).
DecisionMax	64f	Setting for decision threshold maximum (mm).
AbsoluteResult	32u	Setting for selecting absolute or signed result: 0 – Signed result 1 – Absolute result
Feature[2]	Feature	Elements for feature detection.
SourceOptions	String	Constraint for eligible profile sources (comma-delimited list).

### MEASUREMENTS / DISTANCE

A Distance element defines settings for a profile distance measurement.

#### Distance Child Elements

Element	Type	Description
Name	String	Setting for measurement name.
Source	32s	Setting for profile source.
DecisionMin	64f	Setting for decision threshold minimum (mm).
DecisionMax	64f	Setting for decision threshold maximum (mm).
Feature[2]	Feature	Elements for feature detection.
SourceOptions	String	Constraint for eligible profile sources (comma-delimited list).

### MEASUREMENTS / POSITIONX

A PositionX element defines settings for a profile x-position measurement.

#### PositionX Child Elements

Element	Type	Description
Name	String	Setting for measurement name.
Source	32s	Setting for profile source.
DecisionMin	64f	Setting for decision threshold minimum (mm).
DecisionMax	64f	Setting for decision threshold maximum (mm).
Feature	Feature	Element for feature detection.
SourceOptions	String	Constraint for eligible profile sources (comma-delimited list).

### MEASUREMENTS / POSITIONZ

A PositionZ element defines settings for a profile z-position measurement.

#### PositionZ Child Elements

Element	Type	Description
Name	String	Setting for measurement name.
Source	32s	Setting for profile source.
DecisionMin	64f	Setting for decision threshold minimum (mm).
DecisionMax	64f	Setting for decision threshold maximum (mm).
Feature	Feature	Element for feature detection.
SourceOptions	String	Constraint for eligible profile sources (comma-delimited list).

## MEASUREMENTS / CENTERX

A CenterX element defines settings for a profile center-x measurement.

### CenterX Child Elements

Element	Type	Description
Name	String	Setting for measurement name.
Source	32s	Setting for profile source.
DecisionMin	64f	Setting for decision threshold minimum (mm).
DecisionMax	64f	Setting for decision threshold maximum (mm).
Feature[2]	Feature	Elements for feature detection.
SourceOptions	String	Constraint for eligible profile sources (comma-delimited list).

## MEASUREMENTS / CENTERZ

A CenterZ element defines settings for a profile center-z measurement.

### CenterZ Child Elements

Element	Type	Description
Name	String	Setting for measurement name.
Source	32s	Setting for profile source.
DecisionMin	64f	Setting for decision threshold minimum (mm).
DecisionMax	64f	Setting for decision threshold maximum (mm).
Feature[2]	Feature	Elements for feature detection.
SourceOptions	String	Constraint for eligible profile sources (comma-delimited list).

## MEASUREMENTS / ANGLEX

An AngleX element defines settings for a profile angle-x measurement.

### AngleX Child Elements

Element	Type	Description
Name	String	Setting for measurement name.
Source	32s	Setting for profile source.
DecisionMin	64f	Setting for decision threshold minimum (degrees).
DecisionMax	64f	Setting for decision threshold maximum (degrees).
AbsoluteResult	32u	Setting for selecting absolute or signed result: 0 – Signed result 1 – Absolute result
Line	Line	Element for fit line.
SourceOptions	String	Constraint for eligible profile sources (comma-delimited list).

## MEASUREMENTS / INTERSECTX

An IntersectX element defines settings for a profile intersect-x measurement.

### IntersectX Child Elements

Element	Type	Description
Name	String	Setting for measurement name.
Source	32s	Setting for profile source.
DecisionMin	64f	Setting for decision threshold minimum (mm).

Element	Type	Description
DecisionMax	64f	Setting for decision threshold maximum (mm).
Line[2]	Line	Elements for fit lines.
SourceOptions	String	Constraint for eligible profile sources (comma-delimited list).

## MEASUREMENTS / INTERSECTZ

An IntersectZ element defines settings for a profile intersect-z measurement.

### *IntersectZ Child Elements*

Element	Type	Description
Name	String	Setting for measurement name.
Source	32s	Setting for profile source.
DecisionMin	64f	Setting for decision threshold minimum (mm).
DecisionMax	64f	Setting for decision threshold maximum (mm).
Line[2]	Line	Elements for fit lines.
SourceOptions	String	Constraint for eligible profile sources (comma-delimited list).

## MEASUREMENTS / INTERSECTANGLE

An IntersectAngle element defines settings for a profile intersect angle measurement.

### *IntersectAngle Child Elements*

Element	Type	Description
Name	String	Setting for measurement name.
Source	32s	Setting for profile source.
DecisionMin	64f	Setting for decision threshold minimum (degrees).
DecisionMax	64f	Setting for decision threshold maximum (degrees).
AbsoluteResult	32u	Setting for selecting absolute or signed result: 0 – Signed result 1 – Absolute result
Line[2]	Line	Elements for fit lines.
SourceOptions	String	Constraint for eligible profile sources (comma-delimited list).

## MEASUREMENTS / INTERSECTAREA

An IntersectArea element defines settings for a profile intersect area measurement.

### *IntersectArea Child Elements*

Element	Type	Description
Name	String	Setting for measurement name.
Source	32s	Setting for profile source.
DecisionMin	64f	Setting for decision threshold minimum (mm).
DecisionMax	64f	Setting for decision threshold maximum (mm).
Area	Area	Element for measurement area.
Line	Line	Element for measurement baseline.
SourceOptions	String	Constraint for eligible profile sources (comma-delimited list).

## MEASUREMENTS / BOXAREA

A BoxArea element defines settings for a profile box area measurement.

### BoxArea Child Elements

Element	Type	Description
Name	String	Setting for measurement name.
Source	32s	Setting for profile source.
DecisionMin	64f	Setting for decision threshold minimum (mm).
DecisionMax	64f	Setting for decision threshold maximum (mm).
Area	Area	Element for measurement area.
SourceOptions	String	Constraint for eligible profile sources (comma-delimited list).

## MEASUREMENTS / DIFFERENCE AREA

A difference area element defines settings for difference area measurement.

### Difference Area Child Elements

Element	Type	Description
Name	String	Setting for measurement name.
DecisionMin	64f	Setting for decision threshold minimum (mm <sup>2</sup> ).
DecisionMax	64f	Setting for decision threshold maximum (mm <sup>2</sup> ).
AbsoluteResult	32u	Setting for selecting absolute or signed result: 0 – Signed result 1 – Absolute result
Source	32s	Setting for profile source.
Area	Area	Element for measurement area.
SourceOptions	String	Constraint for eligible profile sources (comma-delimited list).

## MEASUREMENTS / DIFFERENCE PEAK

A difference peak element defines settings for difference peak measurement.

### Difference Area Child Elements

Element	Type	Description
Name	String	Setting for measurement name.
DecisionMin	64f	Setting for decision threshold minimum (mm).
DecisionMax	64f	Setting for decision threshold maximum (mm).
AbsoluteResult	32u	Setting for selecting absolute or signed result: 0 – Signed result 1 – Absolute result
Source	32s	Setting for profile source.
Area	Area	Element for measurement area.
SourceOptions	String	Constraint for eligible profile sources (comma-delimited list).

## MEASUREMENTS / SCRIPT

A Script element defines settings for a script measurement.

### Script Child Elements

Element	Type	Description
Name	String	Setting for measurement name.

<b>Element</b>	<b>Type</b>	<b>Description</b>
Code	String	Script code.

## Part

The Part element contains settings that affect part measurements. Simple child elements in Part are defined below:

### *ProfileMeasurement Child Elements*

Element	Type	Description
MeasurementOptions	String	Constraint for available measurement types - comma delimited list (e.g. "Area, Volume").

The Part element also contains two significant sub-elements: Detection and Measurements. The Detection element defines the part detection behavior, while the Measurements element contains one sub-element for each requested part measurement.

The id attribute associated with each measurement defines an identifier that must be unique among all measurements in the configuration file.

e.g. <Area id="1001">

## DETECTION

A detection element defines settings for part detection.

### *Detection Child Elements*

Element	Type	Description
HeightThreshold	64f	Setting for height threshold (mm).
GapThreshold	64f	Setting for gap threshold (mm).
AreaThreshold	64f	Setting for area threshold (mm <sup>2</sup> ).
LengthMax	64f	Setting for maximum length of a part (mm).
HeightThresholdMin	64f	Constraint for height threshold minimum (mm).
HeightThresholdMax	64f	Constraint for height threshold maximum (mm).
GapThresholdMin	64f	Constraint for gap threshold minimum (mm).
GapThresholdMax	64f	Constraint for gap threshold maximum (mm).
AreaThresholdMin	64f	Constraint for area threshold minimum (mm <sup>2</sup> ).
AreaThresholdMax	64f	Constraint for area threshold maximum (mm <sup>2</sup> ).
LengthMaxLimitMin	64f	Constraint for lengthMax minimum (mm).
LengthMaxLimitMax	64f	Constraint for lengthMax maximum (mm).

## MEASUREMENTS / PARTAREA

A PartArea element defines settings for an area measurement.

### *Part Area Child Elements*

Element	Type	Description
Name	String	Setting for measurement name.
DecisionMin	64f	Setting for decision threshold minimum (mm <sup>2</sup> ).
DecisionMax	64f	Setting for decision threshold maximum (mm <sup>2</sup> ).

## MEASUREMENTS / PARTVOLUME

A PartVolume element defines settings for a volume measurement.

Part Volume Child Elements

Element	Type	Description
Name	String	Setting for measurement name.
DecisionMin	64f	Setting for decision threshold minimum (mm <sup>3</sup> ).
DecisionMax	64f	Setting for decision threshold maximum (mm <sup>3</sup> ).

**MEASUREMENTS / PARTHEIGHT**

A PartHeight element defines settings for a height measurement.

Part Height Child Elements

Element	Type	Description
Name	String	Setting for measurement name.
DecisionMin	64f	Setting for decision threshold minimum (mm).
DecisionMax	64f	Setting for decision threshold maximum (mm).
Type	32s	Setting for measurement type: 0 – Minimum 1 – Maximum 2 – 2D Centroid 3 – 3D Centroid

**MEASUREMENTS / PARTCENTROIDX**

A PartCentroidX element defines settings for a centroid X measurement.

Part Centroid X Child Elements

Element	Type	Description
Name	String	Setting for measurement name.
DecisionMin	64f	Setting for decision threshold minimum (mm).
DecisionMax	64f	Setting for decision threshold maximum (mm).
Type	32s	Setting for measurement type: 0 – 2D Centroid 1 – 3D Centroid

**MEASUREMENTS / PARTCENTROIDY**

A PartCentroidY element defines settings for a centroid Y measurement.

Part Centroid Y Child Elements

Element	Type	Description
Name	String	Setting for measurement name.
DecisionMin	64f	Setting for decision threshold minimum (mm).
DecisionMax	64f	Setting for decision threshold maximum (mm).
Type	32s	Setting for measurement type: 0 – 2D Centroid 1 – 3D Centroid

**MEASUREMENTS / PARTCENTROIDZ**

A PartCentroidZ element defines settings for a centroid Z measurement.

#### Part Centroid Z Child Elements

Element	Type	Description
Name	String	Setting for measurement name.
DecisionMin	64f	Setting for decision threshold minimum (mm).
DecisionMax	64f	Setting for decision threshold maximum (mm).
Type	32s	Setting for centroid type: 0 – 2D Centroid 1 – 3D Centroid

#### MEASUREMENTS / PARTELLIPSEMAJOR

A PartEllipseMajor element defines settings for an ellipse major measurement.

#### Part Ellipse Major Child Elements

Element	Type	Description
Name	String	Setting for measurement name.
DecisionMin	64f	Setting for decision threshold minimum (mm).
DecisionMax	64f	Setting for decision threshold maximum (mm).

#### MEASUREMENTS / PARTELLIPSEMINOR

A PartEllipseMinor element defines settings for an ellipse minor measurement.

#### Part Ellipse Minor Child Elements

Element	Type	Description
Name	String	Setting for measurement name.
DecisionMin	64f	Setting for decision threshold minimum (mm).
DecisionMax	64f	Setting for decision threshold maximum (mm).

#### MEASUREMENTS / PARTELLIPSEANGLE

A PartEllipseAngle element defines settings for an ellipse angle measurement.

#### Part Ellipse Angle Child Elements

Element	Type	Description
Name	String	Setting for measurement name.
DecisionMin	64f	Setting for decision threshold minimum (degrees).
DecisionMax	64f	Setting for decision threshold maximum (degrees).

#### MEASUREMENTS / PARTELLIPSERATIO

A PartEllipseRatio element defines settings for an ellipse ratio measurement.

#### Part Ellipse Ratio Child Elements

Element	Type	Description
Name	String	Setting for measurement name.
DecisionMin	64f	Setting for decision threshold minimum.
DecisionMax	64f	Setting for decision threshold maximum.

#### MEASUREMENTS / PARTBOUNDINGBOXX

A PartBoundingBoxX element defines settings for a bounding box X measurement.

#### Part Bounding Box X Elements

Element	Type	Description
Name	String	Setting for measurement name.
DecisionMin	64f	Setting for decision threshold minimum (mm).
DecisionMax	64f	Setting for decision threshold maximum (mm).

#### MEASUREMENTS / PARTBOUNDINGBOXY

A PartBoundingBoxY element defines settings for a bounding box Y measurement.

#### Part Bounding Box Y Elements

Element	Type	Description
Name	String	Setting for measurement name.
DecisionMin	64f	Setting for decision threshold minimum (mm).
DecisionMax	64f	Setting for decision threshold maximum (mm).

#### MEASUREMENTS / PARTBOUNDINGBOXWIDTH

A PartBoundingBoxWidth element defines settings for a bounding box width measurement.

#### Part Bounding Box Width Elements

Element	Type	Description
Name	String	Setting for measurement name.
DecisionMin	64f	Setting for decision threshold minimum (mm).
DecisionMax	64f	Setting for decision threshold maximum (mm).

#### MEASUREMENTS / PARTBOUNDINGBOXLENGTH

A PartBoundingBoxLength element defines settings for a bounding box length measurement.

#### Part Bounding Box Length Elements

Element	Type	Description
Name	String	Setting for measurement name.
DecisionMin	64f	Setting for decision threshold minimum (mm).
DecisionMax	64f	Setting for decision threshold maximum (mm).

#### MEASUREMENTS / SCRIPT

A Script element defines settings for a script measurement.

#### Script Child Elements

Element	Type	Description
Name	String	Setting for measurement name.
Code	String	Script code.

## Output

The Outputs element has the following sub-element types: Ethernet, Serial, Analog, and Digital Output. Each of these subelements defines the output settings for a different type of Gocator output.

The *Source* identifiers that are used with *Video*, *profile*, *part* and *intensity* outputs are *profile source identifiers*. Refer to Profile Sources (page 154) for more information.

The *Source* identifiers that are used with *Value* and *Decision* outputs correspond to the measurement identifiers defined in the Profile and Part element. E.g.

```
<ProfileMeasurement>
...
  <Measurements>
    <Width id="1000">
      ...
    <Height id="2000">
      ...
  ...
</ProfileMeasurement>
<Outputs>
  <Ethernet>
    ...
    <Decision>1000,2000</Decision>
    ...
  ...
</Outputs>
```

## ETHERNET

The Ethernet element defines settings for Ethernet output.

### *Ethernet Child Elements*

Element	Type	Description
Protocol	32s	Setting for selected protocol: 0 – Gocator 1 – Modbus TCP
Video	String	Setting for selected video sources (comma-delimited list).
Profile	String	Setting for selected profile sources (comma-delimited list).
ProfileIntensity	String	Setting for selected profile intensity sources (comma-delimited list).
RawProfile	String	Setting for selected raw profile sources (comma-delimited list).
Part	String	Setting for selected part sources (comma-delimited list).
PartIntensity	String	Setting for selected part intensity sources (comma-delimited list).
Value	String	Setting for selected value sources (comma-delimited list).
Decision	String	Setting for selected decision sources (comma-delimited list).
VideoOptions	String	Constraint for eligible video sources (comma-delimited list).
ProfileOptions	String	Constraint for eligible profile sources (comma-delimited list).
ProfileIntensityOptions	String	Constraint for eligible profile intensity sources (comma-delimited list).
RawProfileOptions	String	Constraint for eligible raw profile sources (comma-delimited list).
PartOptions	String	Constraint for eligible part sources (comma-delimited list).
PartIntensityOptions	String	Constraint for eligible part intensity sources (comma-delimited list).
ValueOptions	String	Constraint for eligible value sources (comma-delimited list).
DecisionOptions	String	Constraint for eligible decision sources (comma-delimited list).

## SERIAL

The Serial element defines settings for Serial output.

### *Serial Child Elements*

Element	Type	Description
Value	String	Setting for selected value sources (comma-delimited list).
Decision	String	Setting for selected decision sources (comma-delimited list).

Element	Type	Description
ValueOptions	String	Constraint for eligible value sources (comma-delimited list).
DecisionOptions	String	Constraint for eligible decision sources (comma-delimited list).

## ANALOG

The Analog element defines settings for Analog output.

The range of valid measurement values [DataScaleMin, DataScaleMax] is scaled linearly to the specified current range [CurrentMin, CurrentMax].

Only one Value or Decision source can be selected at a time.

### Analog Child Elements

Element	Type	Description
CurrentMin	64f	Setting for minimum output current (mA).
CurrentMax	64f	Setting for maximum output current (mA).
CurrentInvalid	64f	Setting for invalid output current (mA).
CurrentInvalidEnable	32u	0 – Output keeps currently value if measurement is invalid. 1 – Outputs CurrentInvalid if measurement is invalid.
DataScaleMin	64f	Setting for measurement value associated with the minimum current.
DataScaleMax	64f	Setting for measurement value associated with the maximum current.
Value	32u	Setting for selected value source.
Decision	32u	Setting for selected decision source.
CurrentLimitMin	64f	Constraint for minimum output current (mA).
CurrentLimitMax	64f	Constraint for maximum output current (mA).
ValueOptions	String	Constraint for eligible value sources (comma-delimited list).
DecisionOptions	String	Constraint for eligible decision sources (comma-delimited list).
Event	32s	Setting for which event control the output: 1 – Measurement 2 – Software
ScheduleEnable	32u	Setting for scheduled output mode. When unscheduled, output updates immediately. When scheduled, output updates according to a target value in software command, or a delay. 0 – Not scheduled 1 – Scheduled
Delay	64f	Setting for output delay. The delay is measured from exposure (first exposure for multiple exposure) to when output is scheduled. Ignored when ScheduleEnable is 0. The units depends on SystemDomain.

The delay specifies the time or position at which the analog output activates. Upon activation, there is an additional delay before the analog output settles at the correct value.

## DIGITAL OUTPUT

A DigitalOutput element defines settings for a digital output. There are two DigitalOutput elements, each identified by a unique id attribute (0 and 1):

```
<DigitalOutput id="0">
```

*DigitalOutput Child Elements*

<b>Element</b>	<b>Type</b>	<b>Description</b>
PassMode	32u	Setting to specify how the state of the output is defined: 0 – Pass if decision is true 1 – Pass if decision is false 2 – Pass always
PulseWidth	32u	Setting for digital pulse width (us).
Decision	String	Setting for selected decision sources (comma-delimited list).
PulseWidthMin	32u	Constraint for minimum pulse width (us).
PulseWidthMax	32u	Constraint for maximum pulse width (us).
DecisionOptions	String	Constraint for eligible decision sources (comma-delimited list).
SignalType	32s	Setting for signal type: 0 – Pulsed output 1 – Continuous output
Event	32s	Setting for which event control the output: 1 – Measurement 2 – Software
ScheduleEnable	32u	Setting for scheduled output mode. When unscheduled, output updates immediately. When scheduled, output updates according to a target value in software command, or a delay. 0 - Not scheduled 1 - Scheduled
Delay	64f	Setting for output delay. The delay is measured from exposure (first exposure for multiple exposure) to when output is scheduled. Ignored when ScheduleEnable is 0. The units depends on SystemDomain.

# Calibration File

The calibration file, transform.xml, contains settings that define the transformation from sensor coordinates to system coordinates, encoder resolution and distance (in direction of travel) between main and buddy sensor.

Use Read and Write File command to modify the calibration file.

## Calibration Example:

```
<?xml version="1.0" ?>
<SysCal version="1">
  <YDomain>0</YDomain>
  <YResolution>0</YResolution>
  <YSpeed>0</YSpeed>
  <Entries>
    <Entry id="0">
      <X>-2.3650924829</X>
      <Z>123.4966803469</Z>
      <Angle>5.7478302588</Angle>
      <Orientation>0</Orientation>
    </Entry>
    <Entry id="1">
      <X>0</X>
      <Z>123.4966803469</Z>
      <Angle>0</Angle>
      <Orientation>0</Orientation>
    </Entry>
  </Entries>
</SysCal>
```

## SysCal

The SysCal element contains the calibration record for both main and buddy sensor. The version attribute defines the version of the record format.

```
<SysCal version="1">
```

### *SysCal Child Elements*

Element	Type	Description
YDomain	32s	Reserved. Must be zero.
YResolution	64f	Encoder Resolution (mm/tick).
YSpeed	64f	Travel Speed (mm/s).

## ENTRIES

An Entry element defines the transformation for a sensor. There is one entry element per sensor, identified by a unique id attribute (0 for main and 1 for buddy):

```
<Entry id="0">
```

### *Entry Child Elements*

Element	Type	Description
X	64f	Translation in the X axis (mm).
Z	64f	Translation in the Z axis (mm).
Angle	64f	Rotation about Y axis (degrees).
Orientation	32u	Direction of X-axis: 0 – Normal 1 – Reverse

# Discovery Commands

## Get Address

The Get Address command is used to discover Gocator sensors across subnets.

### Command

Field	Type	Description
length	64s	Command size, in bytes.
id	64s	Command identifier (0x0001)
signature	64s	Magic number (0x0000504455494D4C).
identifier	64s	Device identifier (serial number) or zero to discover unknown devices.

### Reply

Field	Type	Description
length	64s	Reply size, in bytes.
id	64s	Reply identifier (0x1001).
status	64s	Reply status.
signature	64s	Magic number (0x0000504455494D4C).
deviceId	64s	Device identifier.
useDhcp	64s	1 if network interface uses DHCP, 0 otherwise.
reserved[4]	byte	Reserved.
address[4]	byte	IP address.
reserved[4]	byte	Reserved.
mask[4]	byte	Subnet mask.
reserved[4]	byte	Reserved.
gateway[4]	byte	Gateway.
reserved[4]	byte	Reserved.
reserved[4]	byte	Reserved.

## Set Address

The Set Address command modifies the network configuration of a Gocator sensor. Upon receiving the command, the Gocator will perform a reset. User should wait for 30 seconds before re-connecting to the Gocator.

### Command

Field	Type	Description
length	64s	Command size, in bytes.
id	64s	Command identifier (0x0002).
signature	64s	Magic number (0x0000504455494D4C).
deviceld	64s	Device identifier (serial number).
useDhcp	64s	1 if network interface uses DHCP, 0 otherwise.
reserved[4]	byte	Reserved. Set to 0.
address[4]	byte	IP address.
reserved[4]	byte	Reserved. Set to 0.
mask[4]	byte	Subnet mask.
reserved[4]	byte	Reserved. Set to 0.
gateway[4]	byte	Gateway.
reserved[4]	byte	Reserved. Set to 0.
reserved[4]	byte	Reserved. Set to 0.

### Reply

Field	Type	Description
length	64s	Reply size – in bytes.
id	64s	Reply identifier (0x1002).
status	64s	Reply status.
signature	64s	Magic number (0x0000504455494D4C).
deviceld	64s	Device identifier.

# Upgrade Commands

## Get Protocol Version

The Get Protocol Version command reports the Upgrade protocol version of the connected sensor.

### Command

Field	Type	Description
length	64s	Command size – in bytes.
id	64s	Command identifier (0x0100).

### Reply

Field	Type	Description
length	64s	Reply size – in bytes.
id	64s	Reply identifier.
status	64s	Reply status.
majorVersion	64s	Major version.
minorVersion	64s	Minor version.

## Start Upgrade

The Start Upgrade command begins a firmware upgrade for the main sensor and any Buddy sensors. All sensors will automatically reset 3 seconds after upgrade process is complete.

### Command

Field	Type	Description
length	64s	Command size – in bytes.
id	64s	Command identifier (0x0000).
fileSize	64s	Upgrade file size – in bytes.
file[fileSize]	byte	Upgrade file.

### Reply

Field	Type	Description
length	64s	Reply size – in bytes.
id	64s	Reply identifier.
status	64s	Reply status.

## Get Upgrade Status

The Get Upgrade Status command determines the progress of a firmware upgrade.

### Command

Field	Type	Description
length	64s	Command size – in bytes.
id	64s	Command identifier (0x0001).

### Reply

Field	Type	Description
length	64s	Reply size – in bytes.
id	64s	Reply identifier.
status	64s	Reply status.

Field	Type	Description
stage	64s	Current upgrade stage: -1 – Upgrade Failed 0 – Upgrade Completed 1 – Upgrade in Progress
progress	64s	Percentage completed – valid when stage is Upgrade in Progress.

## Get Upgrade Log

The Get Upgrade Log command can retrieve an upgrade log in the event of upgrade problems.

### Command

Field	Type	Description
length	64s	Command size – in bytes.
id	64s	Command identifier (0x0002).

### Reply

Field	Type	Description
length	64s	Reply size – in bytes.
id	64s	Reply identifier.
status	64s	Reply status.
fileSize	64s	Log file size – in bytes.
file[fileSize]	byte	Log file.

# Control Commands

## Get Protocol Version

The Get Protocol Version command reports the Control protocol version of the connected sensor.

### Command

Field	Type	Description
length	64s	Command size – in bytes.
id	64s	Command identifier (0x4511).

### Reply

Field	Type	Description
length	64s	Reply size – in bytes.
id	64s	Reply identifier.
status	64s	Reply status.
majorVersion	64s	Major version.
minorVersion	64s	Minor version.

## Get System Info

The Get System Info command reports information for sensors that are visible in the system.

### Command

Field	Type	Description
length	64s	Command size – in bytes.
id	64s	Command identifier (0x4002).

### Reply

Field	Type	Description
length	64s	Reply size – in bytes.
id	64s	Reply identifier.
status	64s	Reply status.
deviceld	64s	Connected sensor device id (serial number).
firmwareVersion	64s	Connected sensor firmware version.
modelName[32]	char	Connected sensor model name (null-terminated).
role	64s	Connected sensor network role: 0 – Standalone 1 – Main (in a Buddy setup) 2 – Buddy
loginState	64s	Authenticated user: 0 – None 1 – Administrator 2 – Technician
systemState	64s	Current system state: 1 – Conflict 2 – Ready 3 – Running

Field	Type	Description
calibrationType	64s	Current calibration state: 0 – Not calibrated 1 – Auto calibrated 2 – Manual calibrated
hasBuddy	64s	Current buddy assignment state: 0 – No Buddy assigned 1 – Buddy assigned
BuddyInfo	BuddyInfo	Assigned Buddy information (not present if hasBuddy is 0).
sensorCount	64s	Count of visible sensors.
sensorInfo[sensorCount]	SensorInfo	Sensor Information (see format below).

#### *BuddyInfo*

Field	Type	Description
deviceId	64s	Buddy device id.
state	64s	Sensor Buddy state: 0 – Connected 1 – Missing 2 – Error
modelName[32]	char	Sensor model name.
firmwareVersion	64s	Buddy firmware version.

#### *SensorInfo*

Field	Type	Description
deviceId	64s	Sensor device id.
state	64s	Sensor state: 0 – Paired (not set for main sensor) 1 – Available 2 – Unavailable
modelName[32]	char	Sensor model name (null-terminated).
firmwareVersion	64s	Sensor firmware version.

## Log In/Out

The Log In/Out command is used to log in or out of a sensor.

#### *Command*

Field	Type	Description
length	64s	Command size – in bytes.
id	64s	Command identifier (0x4003).
userType	64s	User account: 0 – None (log out) 1 – Administrator 2 – Technician
password[64]	char	Password (null-terminated; required for log-in only).

#### *Reply*

Field	Type	Description
length	64s	Reply size – in bytes.
id	64s	Reply identifier.
status	64s	Reply status.

## Change Password

The Change Password command is used to change log-in credentials for a user.

### Command

Field	Type	Description
length	64s	Command size – in bytes.
id	64s	Command identifier (0x4004).
user type	64s	User account: 1 – Administrator 2 – Technician
password[64]	char	New password (null-terminated).

### Reply

Field	Type	Description
length	64s	Reply size – in bytes.
id	64s	Reply identifier.
status	64s	Reply status.

## Change Buddy

The Change Buddy command is used to assign or unassign a Buddy sensor.

### Command

Field	Type	Description
length	64s	Command size - in bytes.
id	64s	Command identifier (0x4005).
action	64s	Action to take: 0 – Unassign Buddy. 1 – Assign Buddy.
count	64s	Count of sensors affected by action (must be 1 at present).
deviceId[count]	64s	List of target sensors.

### Reply

Field	Type	Description
length	64s	Reply size - in bytes.
id	64s	Reply identifier.
status	64s	Reply status.

## Get File List

The Get File List command reports the list of available files on the connected sensor.

### Command

Field	Type	Description
length	64s	Command size - in bytes.
id	64s	Command identifier (0x101A).
extension[64]	char	Null-terminated file extension filter, or empty: cfg – Configuration files rec – Record/Playback data files prof – Profile template files xml – XML file

### Reply

Field	Type	Description
length	64s	Reply size – in bytes.
id	64s	Reply identifier.
status	64s	Reply status.
count	64s	Number of file names returned.
name[count][64]	char	List of file names.

## Copy File

The Copy File command copies a file from a source to a destination within the connected sensor.

### Command

Field	Type	Description
length	64s	Command size – in bytes.
id	64s	Command identifier (0x101B).
source [64]	char	Source file name (null-terminated).
destination [64]	char	Destination file name (null-terminated).

### Reply

Field	Type	Description
length	64s	Reply size – in bytes.
id	64s	Reply identifier.
status	64s	Reply status.

## Read File

Downloads a file from the connected sensor.

### Command

Field	Type	Description
length	64s	Command size – in bytes.
id	64s	Command identifier (0x1007).
fileName[64]	char	File name (null-terminated).

### Reply

Field	Type	Description
length	64s	Reply size – in bytes.
id	64s	Reply identifier.
status	64s	Reply status.
fileSize	64s	File size – in bytes.
file[fileSize]	byte	File content.

## Write File

The Write File command uploads a file to the connected sensor.

### Command

Field	Type	Description
length	64s	Command size – in bytes.
id	64s	Command identifier (0x1006).

Field	Type	Description
fileName[64]	char	File name (null-terminated).
fileSize	64s	File size – in bytes.
file[fileSize]	byte	File content.

*Reply*

Field	Type	Description
length	64s	Reply size – in bytes.
id	64s	Reply identifier.
status	64s	Reply status.

## Delete File

The Delete File command removes a file from the connected sensor.

*Command*

Field	Type	Description
length	64s	Command size – in bytes.
id	64s	Command identifier (0x1008).
fileName[64]	char	File name (null-terminated).
fileSize	64s	File size – in bytes.
file[fileSize]	byte	File content.

*Reply*

Field	Type	Description
length	64s	Reply size – in bytes.
id	64s	Reply identifier.
status	64s	Reply status.

## Get Default File

The Get Default File command gets the name of a default file that will be loaded at boot time. Default files can be defined for configuration, calibration, and profile templates (differentiated by extension).

*Command*

Field	Type	Description
length	64s	Command size – in bytes.
id	64s	Command identifier (0x4100).
extension[64]	char	Null-terminated file extension: cfg – Configuration files rec – Record/Playback data files prof – Profile template files

*Reply*

Field	Type	Description
length	64s	Reply size – in bytes.
id	64s	Reply identifier.
status	64s	Reply status.
fileName[64]	char	File name (null-terminated).

## Set Default File

The Set Default File command sets the name of a default file that will be loaded at boot time. Default files can be defined for configuration, calibration, and profile templates (differentiated by extension).

### Command

Field	Type	Description
length	64s	Command size – in bytes.
id	64s	Command identifier (0x4101).
fileName[64]	char	File name (null-terminated).

### Reply

Field	Type	Description
length	64s	Reply size – in bytes.
id	64s	Reply identifier.
status	64s	Reply status.

## Get Loaded File

The Get Loaded File command returns the currently loaded (i.e. live) file name and modified status for a file type.

### Command

Field	Type	Description
length	64s	Command size – in bytes.
id	64s	Command identifier (0x4512).
extension[64]	char	Extension for the file type: cfg – Configuration files prof – Profile template files

### Reply

Field	Type	Description
length	64s	Reply size – in bytes.
id	64s	Reply identifier.
status	64s	Reply status.
fileName[64]	char	Name of the currently loaded file.
changed	64	Whether or not the currently loaded file has been changed (1: yes; 0: no).

## Get Mode

The Get Mode command reports the name of the current system mode.

### Command

Field	Type	Description
length	64s	Command size – in bytes.
id	64s	Command identifier (0x1005).

### Reply

Field	Type	Description
length	64s	Reply size – in bytes.
id	64s	Reply identifier.
status	64s	Reply status.
mode[16]	char	Mode name (null-terminated).

## Set Mode

The Set Mode command sets the name of the current system mode.

### Command

Field	Type	Description
length	64s	Command size – in bytes.
id	64s	Command identifier (0x1004).
mode[16]	char	Mode name (null-terminated).

### Reply

Field	Type	Description
length	64s	Reply size – in bytes.
id	64s	Reply identifier.
status	64s	Reply status.

## Get Time

This command retrieves the system clock, in microseconds. All devices in a system are synchronized with the system clock; this value can be used for diagnostic purposes, or used to synchronize the start time of the system.

### Command

Field	Type	Description
length	64s	Command size – in bytes.
id	64s	Command identifier (0x100A).

### Reply

Field	Type	Description
length	64s	Reply size – in bytes.
id	64s	Reply identifier (0x100A).
status	64s	Reply status.
time	64u	Current time, in microseconds.

## Get Encoder

This command retrieves the current system encoder value.

### Command

Field	Type	Description
length	64s	Command size – in bytes.
id	64s	Command identifier (0x101C).

### Reply

Field	Type	Description
length	64s	Reply size – in bytes.
id	64s	Reply identifier (0x101C).
status	64s	Reply status.
encoder	64s	Current encoder value, in ticks.

## Start

The Start command starts the sensor system (system enters the Running state).

### Command

Field	Type	Description
length	64s	Command size – in bytes.
id	64s	Command identifier (0x100D).
reserved	64s	Reserved field – set to 0.

### Reply

Field	Type	Description
length	64s	Reply size – in bytes.
id	64s	Reply identifier.
status	64s	Reply status.

## Scheduled Start

The scheduled start command starts the sensor system (system enters the Running state) at target time or encoder value (depending on the trigger mode).

The time and encoder targets value should be set by adding a delay to the time and/or encoder tick returned by Get Time and Get Encoder command. The delay should be set such that it covers the command response time of the Scheduled start command.

### Command

Field	Type	Description
length	64s	Command size – in bytes.
id	64s	Command identifier (0x101D).
time target	64s	Specify start time target, in microseconds.
encoder target	64s	Specify start encoder target in ticks.

### Reply

Field	Type	Description
length	64s	Reply size – in bytes.
id	64s	Reply identifier (0x101D).
status	64s	Reply status.

## Stop

The Stop command stops the sensor system (system enters the Ready state).

### Command

Field	Type	Description
length	64s	Command size – in bytes.
id	64s	Command identifier (0x1001).

### Reply

Field	Type	Description
length	64s	Reply size – in bytes.
id	64s	Reply identifier.
status	64s	Reply status.

## Trigger

The Trigger command applies a software trigger to the system. The system must be configured to accept software triggers and must be in the Running State.

### Command

Field	Type	Description
length	64s	Command size – in bytes.
id	64s	Command identifier (0x4510).

### Reply

Field	Type	Description
length	64s	Reply size – in bytes.
id	64s	Reply identifier.
status	64s	Reply status.

## Scheduled Digital Output

The Scheduled Digital Output command schedules a digital output event. The system must be configured to accept software scheduled command and can be in the Running State.

### Command

Field	Type	Description
length	64s	Command size – in bytes.
id	64s	Command identifier (0x4518).
index	64s	Index of the output (starts from 0)
target	64s	Specifies the time (us) or position (encoder ticks) of when the event should happen.
value	64s	Specifies the target state: 0 – Set to low (continuous) 1 – Set to high (continuous) Ignored if output type is pulsed.

### Reply

Field	Type	Description
length	64s	Reply size – in bytes.
id	64s	Reply identifier.
status	64s	Reply status.

## Scheduled Analog Output

Scheduled Analog Output command schedules a analog output event. The system must be configured to accept software scheduled command and can be in the Running State.

### Command

Field	Type	Description
length	64s	Command size – in bytes.
id	64s	Command identifier (0x4519).
index	64s	Index of the output. Must be 0.
target	64s	Specifies the time (us) or position (encoder ticks) of when the event should happen.
value	64s	Output current (nano amperes).

#### Reply

Field	Type	Description
length	64s	Reply size – in bytes.
id	64s	Reply identifier.
status	64s	Reply status.

Note that the analog output takes about 75 us to reach 90% of the target value for a maximum change, then another ~40 us to settle completely.

## Ping

The Ping command can be used to test the control connection. This command has no effect.

#### Command

Field	Type	Description
length	64s	Command size – in bytes.
id	64s	Command identifier (0x100E).
reserved	64s	Reserved – set to 0.

#### Reply

Field	Type	Description
length	64s	Reply size – in bytes.
id	64s	Reply identifier.
status	64s	Reply status.

## Reset

The Reset command reboots the main sensor and any Buddy sensors. All sensors will automatically reset 3 seconds after the reply to this command is transmitted.

#### Command

Field	Type	Description
length	64s	Command size – in bytes.
id	64s	Command identifier (0x4300).

#### Reply

Field	Type	Description
length	64s	Reply size – in bytes.
id	64s	Reply identifier.
status	64s	Reply status.

## Backup

The Backup command creates a backup of all files stored on the connected sensor and downloads the backup to the client.

#### Command

Field	Type	Description
length	64s	Command size – in bytes.
id	64s	Command identifier (0x1013).

### Reply

Field	Type	Description
length	64s	Reply size – in bytes.
id	64s	Reply identifier.
status	64s	Reply status.
fileSize	64s	Size of backup file – in bytes.
file[fileSize]	byte	Backup file content.

## Restore

The Restore command uploads a backup file to the connected sensor and then restores all sensor files from the backup.

Note that the sensor must be reset or power-cycled before the restore operation can be completed.

### Command

Field	Type	Description
length	64s	Command size – in bytes.
id	64s	Command identifier (0x1014).
fileSize	64s	Size of backup file – in bytes.
file[fileSize]	byte	Backup file content.

### Reply

Field	Type	Description
length	64s	Reply size – in bytes.
id	64s	Reply identifier.
status	64s	Reply status.

## Restore Factory

The Restore Factory command restores the connected sensor to factory default settings. This command has no effect on connected Buddy sensors.

Note that the sensor must be reset or power-cycled before the factory restore operation can be completed.

### Command

Field	Type	Description
length	64s	Command size – in bytes.
id	64s	Command identifier (0x4301).
resetAddress	64s	Specifies whether network address should be restored to default: 0 – Do not reset address 1 – Reset address

### Reply

Field	Type	Description
length	64s	Reply size – in bytes.
id	64s	Reply identifier.
status	64s	Reply status.

## Set Connection Type

The Set Connection Type command sets the type of the master the sensor is connected to.

Note that the master type is saved to non-volatile storage when this command is issued.

### Command

Field	Type	Description
length	64s	Command size – in bytes.
id	64s	Command identifier (0x4514).
type	64s	Connection type: 0 – None 1 – Master 100 2 – Master 200 3 – Master 400 4 – Master 800 5 – Master 1200 6 – Master 2400

### Reply

Field	Type	Description
length	64s	Reply size – in bytes.
id	64s	Reply identifier.
status	64s	Reply status.

## Get Connection Type

The Get Connection Type command returns to the set connection type.

### Command

Field	Type	Description
length	64s	Command size – in bytes.
id	64s	Command identifier (0x4515).

### Reply

Field	Type	Description
length	64s	Reply size – in bytes.
id	64s	Reply identifier.
status	64s	Reply status.
type	64s	Connection type (see Set Connection Type above).

# Data Results

A Data Result message adheres to the general structure for result messages as defined in Result Format (page 156)

A Data Result contains a variable number of blocks depending on the sources selected for Ethernet output. Each selected source contributes two data blocks (and accompanying data block descriptors): one block for attributes and one block for content such as video pixels or measurement results.

## Data Result Header

Field	Type	Description
length	64s	Message length – in bytes.
id	64s	Message id (1).
attributeCount	64s	Count of attributes in this message header (7).
dataCount	64s	Count of data blocks in this message (variable).
reserved	64s	Reserved for internal use.
timestamp	64s	Timestamp (us).
encoder	64s	Encoder value (ticks).
frameCount	64s	Frame count.
digitalInputs	64s	Digital input states.
encoderIndex	64s	Encoder value when the last index is triggered.
reserved	64s	Reserved for internal use.
descriptors[dataCount]	Descriptor	List of data block descriptors.
data[dataCount]	-	List of data blocks.

The formats of the data blocks contributed from specific data sources are described in the following sections.

## Video

### Video Attributes

Field	Type	Description
dataType	64s	Data type (0x00).
source	64s	Video source.
width	64s	Image width (pixel).
height	64s	Image height (pixel).
type	64s	Pixel data type (0x00).
exposure	64s	Exposure (us).
reserved{N}	64s	A variable number of additional attributes may be included.

### Video Data

Field	Type	Description
pixels[height][width]	Byte	Image pixels (dimensions and data type given by block descriptor).

## Profile

### Profile Attributes

Field	Type	Description
dataType	64s	Data type: 0x01 – Resampled profile 0x02 – Raw profile

Field	Type	Description
source	64s	Profile source.
xResolution	64s	X resolution (nm).
zResolution	64s	Z resolution (nm).
xOffset	64s	X offset (nm).
zOffset	64s	Z offset (nm).
exposure	64s	Exposure (us). Set to zero if multiple exposure mode is used.
reserved[N]	64s	A variable number of additional attributes may be included.

#### *Profile Data (resampled)*

Field	Type	Description
ranges[rangeCount]	16s	Range values (unit is z-resolution, 0x8000 represents null range). Dimensions and data type given by block descriptor.

#### *Profile Data (raw)*

Field	Type	Description
ranges[rangeCount][2]	16s	X values and range values (unit are X-resolution and Z-resolution respectively. 0x8000 represents NULL point). Dimensions and data type given by block descriptor.

## Profile Intensity

#### *Profile Intensity Attributes*

Field	Type	Description
dataType	64s	Data type: 0x7 – Resampled profile intensity values 0x8 – Raw profile.intensity values
source	64s	Profile source.
reserved[N]	64s	A variable number of additional attributes may be included.

#### *Profile Intensity Data (resampled or raw)*

Field	Type	Description
intensityValues[rangeCount]	8ulnten	Array of profile intensity values. Items in the array are arranged in the same order as items in the part profile array. A value of 0 indicates no spot. Dimensions and data type given by block descriptor.

## Part Profile

#### *Part Profile Attributes*

Field	Type	Description
dataType	64s	Data type (0x03).
source	64s	Profile source.
xResolution	64s	X resolution (nm).
yResolution	64s	Y resolution (nm).
zResolution	64s	Z resolution (nm).
xOffset	64s	X offset (nm).
yOffset	64s	Y offset (nm).
zOffset	64s	Z offset (nm).
reserved[N]	64s	A variable number of additional attributes may be included.

#### Part Profile Data

Field	Type	Description
ranges[partLength] [partWidth]	16s	Range values (unit is z-resolution, 0x8000 represents null range). Dimensions and data type given by block descriptor.

## Part Intensity

#### Part Intensity Attributes

Field	Type	Description
dataType	64s	Data type (0x09).
source	64s	Profile source.
xOffset	64s	X offset (nm).
yOffset	64s	Y offset (nm).
xResolution	64s	X resolution (nm).
yResolution	64s	Y resolution (nm).
reserved[N]	64s	A variable number of additional attributes may be included.

#### Part Intensity Data

Field	Type	Description
intensityValues[partLength] [partWidth]	8u	Array of profile intensity values. Items in the array are arranged in the same order as items in the part profile array. A value of 0 indicates no spot. Dimensions and data type given by block descriptor.

## Alignment Calibration

#### Alignment Calibration Attributes

Field	Type	Description
dataType	64s	Data type (0x04).
reserved[N]	64s	A variable number of additional attributes may be included.

#### Alignment Calibration Data

Field	Type	Description
status	64s	Calibration result.

## Travel Calibration

#### Travel Calibration Attributes

Field	Type	Description
dataType	64s	Data type (0x05).
reserved[N]	64s	A variable number of additional attributes may be included.

#### Travel Calibration Data

Field	Type	Description
status	64s	Calibration result.

## Exposure Calibration

#### Exposure Calibration Attributes

Field	Type	Description
dataType	64s	Data type (0x06).
reserved[N]	64s	A variable number of additional attributes may be included.

### Exposure Calibration Data

Field	Type	Description
status	64s	Calibration result.

## Measurement

### Measurement Attributes

Field	Type	Description
dataType	64s	Data type (0x10, 0x11, 0x12, or 0x20).
measurementType	64s	Measurement type: 0x00 – Width (um) 0x01 – Height (um) 0x02 – Distance (um) 0x03 – Center X (um) 0x04 – Center Z (um) 0x05 – Position X (um) 0x06 – Position Z (um) 0x10 – Intersect X (um) 0x11 – Intersect Z (um) 0x12 – Intersect Angle (millidegrees) 0x13 – Angle X (millidegrees) 0x20 – Intersect Area (0.001 mm <sup>2</sup> ) 0x21 – Box Area (0.001 mm <sup>2</sup> ) 0x40 – Area (0.001 mm <sup>2</sup> ) 0x41 – Volume (0.001 mm <sup>3</sup> ) 0x42 – Part Height (um) 0x43 – Centroid X (um) 0x44 – Centroid Y (um) 0x45 – Centroid Z (um) 0x46 – Ellipse Major (um) 0x47 – Ellipse Minor (um) 0x48 – Ellipse Angle (millidegrees) 0x49 – Ellipse Ratio 0x4A – Bounding Box X (um) 0x4B – Bounding Box Y (um) 0x4C – Bounding Box Width (um) 0x4D – Bounding Box Length (um) 0x30 – Script (script-specific)
id	64s	Unique id of the measurement – as defined in the configuration.
reserved[N]	64s	A variable number of additional attributes may be included.

### Measurement Data

Field	Type	Description
value	64s	Result value.
decision	64s	Result decision: 0 – Fail 1 – Pass

# Health Results

A Health Result message adheres to the general structure for result messages as defined in Result Format (page 156)

A Health Result contains a single data block for health *indicators*. Each indicator reports the current status of some aspect of the sensor system, such as CPU utilization or network throughput.

## Health Result Header

Field	Type	Description
length	64s	Message length, in bytes.
id	64s	Message id (1000).
attributeCount	64s	Count of attributes in this message header (1).
dataCount	64s	Count of data blocks in this message (1).
deviceId	64s	Sensor device id.
descriptors[dataCount]	Descriptor	List of data block descriptors.
data[dataCount]	-	List of data blocks.

The health data block contains a 2 dimensional array of indicator data. Each row in the array has the following format:

## Health Indicator Format

Field	Type	Description
id	64s	Indicator identifier (indicators are defined below).
instance	64s	Indicator instance.
value	64s	Indicator value.

The following health indicators are defined for Gocator sensor systems:

## Health Indicators

Indicator	Id	Instance	Value
Encoder Value	1003	-	Current system encoder tick.
Encoder Index	1004	-	Current system encoder index.
Encoder Frequency	1005	-	Current system encoder frequency (ticks/s).
Firmware Version	2000	-	Firmware application version.
Temperature	2002	-	Internal temperature (degrees Celsius).
Memory Used	2003	-	Amount of memory currently used (bytes).
Memory Capacity	2004	-	Total amount of memory available (bytes).
Storage Used	2005	-	Amount of non-volatile storage used (bytes).
Storage Capacity	2006	-	Total amount of non-volatile storage available (bytes).
CPU Used	2007	-	CPU usage (percentage of maximum).
Net Out Used	2008	-	Current outbound network throughput (bytes/s).
Net Out Capacity	2009	-	Total available outbound network throughput (bytes/s).
State	2010	-	Current system state.
Camera Errors	2011	-	Number of camera frame errors encountered.
Camera Drops	2012	-	Number of camera frames dropped.
Processing Drops	2015	-	Number of messages dropped before data processing.
Ethernet Drops	2016	-	Number of messages generated but not sent.
Uptime	2017	-	Time elapsed since boot-up or reset (seconds).
Speed	2018	-	Current speed (Hz).
Trigger Drops	2019	-	Number of dropped triggers.
Valid Measurements	20000	-	Number of valid measurements.

<b>Indicator</b>	<b>Id</b>	<b>Instance</b>	<b>Value</b>
Invalid Measurements	20001	–	Number of invalid measurements.
Digital Output Pass	20002	Output index	Number of pass digital output pulses.
Digital Output Fail	20003	Output Index	Number of fail digital output pulses.
Valid Spot Count	20006	–	Number of valid spots that are detected
Part Count	40002	–	Number of parts that are detected
Processing Latency	20007	–	Last delay from camera exposure to when results can be scheduled to Rich I/O.
Max Processing Latency	20008	–	Maximum delay from camera exposure to when results can be scheduled to Rich I/O. Reset on start.
Max Spot Count	20009	–	Maximum number of spots that can be detected.
Measurement	30000	Measurement id	Measurement value.
Measurement Pass	30001	Measurement id	Number of pass decisions.
Measurement Fail	30002	Measurement id	Number of fail decisions.
Measurement Minimum	30003	Measurement id	Minimum measurement value.
Measurement Maximum	30004	Measurement id	Maximum measurement value.

 Additional undocumented indicator values may be included in addition to the indicators defined above.

# Modbus TCP Protocol

Modbus TCP is designed to allow industrial equipment such as Programmable Logic Controllers (PLC), sensors and physical input/output devices to communicate over an Ethernet network.

Modbus/TCP embeds a Modbus frame into a TCP frame in a simple manner. This is a connection-oriented transaction and every query expects a response.

This chapter describes the Modbus TCP commands and data formats. Modbus TCP communication enables the client to:

- Switch to a different active configuration.
- Calibrate and run sensors.
- Receive sensor states, stamps and measurement results.

Modbus TCP is enabled in the Output panel. For more information, refer to Ethernet Control and Output (page 124).

## Concepts

A PLC sends a command to start each Gocator. The PLC then periodically queries each Gocator for its latest measurement results. In Modbus terminology, the PLC is a Modbus Client. Each Gocator is a Modbus Server which serves the results to the PLC.

The Modbus TCP protocol uses TCP for connection and messaging. The PLC makes a TCP connection to the Gocator on port 502. Control and data messages are communicated on this TCP connection. Up to four clients can be connected to the Gocator simultaneously. A connection will be closed after 10 minutes of inactivity.

# Messages

All Modbus TCP messages consist of a MBAP header (Modbus Application Protocol), a function code and a data payload.

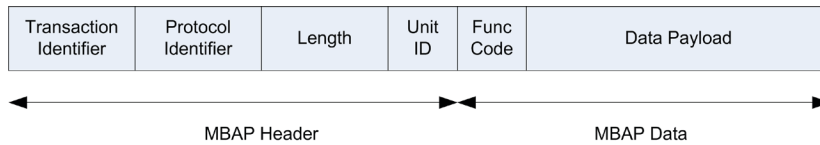

The MBAP header contains the following field:

## *Modbus Application Protocol Header*

Fields	Length (Bytes)	Description
Transaction ID	2	Used for transaction pairing. The Modbus Client sets the value and the Server (Gocator) copies the value into its responses.
Protocol ID	1	Always set to 0.
Length	1	Byte count of the rest of the message, including the Unit identifier and data fields.
Unit ID	1	Used for intra-system routing purpose. The Modbus Client sets the value and the Server (Gocator) copies the value into its responses.

Modbus Application Protocol Specification describes the standard function codes in details. Gocator supports the following function codes:

## *Modbus Function Code*

Function Code	Name	Data Size (bit)	Description
3	Read Holding Registers	16	Read multiple data values from the sensor.
4	Read Input Registers	16	Read multiple data values from the sensor.
6	Write Single Register	16	Send a command or parameter to the sensor.
16	Write Multiple Registers	16	Send a command and parameters to the sensor.

The Data payload contains the registers that can be accessed by Modbus TCP messages. If a message access registers that are invalid, a reply with an exception is returned. Modbus Application Protocol Specification defines the exceptions and describes the data payload format for each function code.

The Gocator data includes 16-bit, 32-bit and 64-bit data. All data are sent in big endian format, with the 32-bit and 64-bit data spread out into two and four consecutive registers.

*32-bit Data Format*

Register	Name	Bit Position
0	32-bit Word 1	31 .. 16
1	32-bit Word 0	15 .. 0

*64-bit Data Format*

Register	Name	Bit Position
0	64-bit Word 3	63 .. 48
1	64-bit Word 2	47 .. 32
2	64-bit Word 1	31 .. 16
3	64-bit Word 0	15 .. 0

# Registers

Modbus registers are 16-wide and are either control registers or output registers.

Control registers are used to control the sensor states(e.g. start, stop or calibrate a sensor), and the output registers report the sensor states, stamps measurement values and decisions. User can read multiple output registers using a single Read Holding Registers or a single Read Input Registers command. Likewise, user can control the state of the sensor using a single Write Multiple Register command.

Control registers are write-only, and output registers are read-only.

## Register Map Overview

Register Address	Name	Read/Write	Description
0 - 124	Control Registers	WO	Registers for Modbus commands. Refer to Control Registers (page 202) for detailed descriptions.
300 -371	Sensor States	RO	Report sensor states. Refer to Output Registers (page 203) for detailed descriptions.
900 - 999	Stamps	RO	Return stamps associated with each profile. Refer to Output Registers (page 203) for detailed descriptions.
1000 - 1060	Measurements & Decisions	RO	20 Measurement and decision pairs. Refer to Measurement Registers (page 204) for detailed descriptions.

## Control Registers

Control registers are used to operate the sensor. Register 0 stores the command to be executed. Register 1-21 contain parameters for the commands. The Gocator executes a command when the value in Register 0 is changed. To set the parameters before a command is executed, user should setup the parameters and the command using a single Multiple Write register command.

### Control Register Map

Register Address	Name	Read/Write	Description
0	Command Register	WO	Command register. Refer to the Command Register Values table below for more information.
1 – 21	Configuration Filename	WO	Null terminated File Name. Specifies the complete filename, including the file extension ".cfg": i.e. "test.cfg" (must be null terminated) Each 16-bit register holds a single character. Only used for Load Configuration Command.

The values used for the Command Register is described below.

### Command Register Values

Value	Name	Description
0	Stop running	Stop the sensor. No effect if sensor is already stopped.
1	Start Running	Start the sensor. No effect if sensor is already started.
2	Alignment Calibrate	Start the alignment calibration process. State register 301 will be set to 1 (busy) until the calibration process is complete.
3	Travel Calibrate	Start the travel calibration process. State register 301 will be set to 1 (busy) until the calibration process is complete.
4	Clear Calibration	Clear the calibration.

Value	Name	Description
5	Load Configuration	Activate a configuration file. Registers 1 - 21 specifies the filename.

## Output Registers

Output registers are used to output states, stamps and measurements results. Each register address holds a 16-bit data value.

State report the current sensor state.

### State Register Map

Register Address	Name	Data Size (bit)	Description
300	Stopped / Running	8	Sensor State: 0 - Stopped 1 - Running
301	Busy	8	Busy State: 0 - Not busy 1 - busy Registers 302-> 363 below are only valid when the Busy State is not busy
302	Calibration State	8	Current Calibration State: 0 - Not calibrated 1- Calibrated
303 – 306	Encoder Value	64	Current Encoder value (ticks).
307 – 310	Time	64	Current time (us).
311 – 371	Live Configuration Name	8 bit for each character	Current Configuration Name. Name of currently loaded config file. does not include the ".cfg" extension. Each 16-bit register contains a single character.

Stamps contain profile trigger timing information used for synchronizing PLC's actions. PLC can also use this information to match up data from multiple Gocator sensors.

In Profile mode, the stamps are updated after each profile is processed. In Part mode, the stamps are updated after each discrete part has been processed.

### Stamp Register Map

Register Address	Name	Data Size (bit)	Description
979	Inputs	8	Digital input state.
980 – 983	Encoder Index	64	Encoder value when the index is last triggered.
984 – 985	Exposure	32	Exposure (us).
986 – 987	Temperature	32	Sensor temperature (mC).
988 – 991	Encoder Value	64	Encoder value (ticks).
992 – 995	Timestamp	64	Time (us).
996 – 999	Frame Counter	64	Frame counter.

## Measurement Registers

Measurement results are reported in pairs of value and decision. Measurement values are 32-bit wide and decisions are 8-bit wide.

The measurement ID defines the register address of each pair. The register address of the first word can be calculated as  $(1000 + 3 * ID)$ . For example, a measurement with ID set to 4 can be read from registers 1012 (high word), 1013 (low word) and the decision at 1015.

In Profile mode, the measurement results are updated after each profile is processed. In Whole Part mode, the measurement results are updated after each discrete part has been processed.

Measurement Register Map

Register Address	Name	Data Size (bit)	Description
1000 – 1001	Measurement ID 0 Value	32	Measurement ID 0 Value
1002	Measurement ID 0 Decision	8	Measurement ID 0 Decision
1003 – 1004	Measurement ID 1 Value	32	Measurement ID 1 Value
1005	Measurement ID 1 Decision	8	Measurement ID 1 Decision
...	...	...	...

# Serial Protocol

This chapter describes the RS-485 serial communication settings and message formats supported by Gocator sensors.

Gocator's serial communication is unidirectional (output only). While measurement values and decisions can be transmitted to an RS-485 receiver, configuration and control operations must be performed through the Gocator's web interface or Ethernet Protocol.

Refer to Serial Output (page 229) for cable pinout information.

## Connection Settings

Gocator serial communication uses the following connection settings:

### *Serial Connection Settings*

<b>Parameter</b>	<b>Value</b>
Start Bits	1
Stop Bits	1
Parity	None
Data Bits	8
Baud Rate (b/s)	115200
Format	ASCII
Delimiter	CR (0xD)

# Message Format

Measurement information is transmitted in a series of ASCII frames each terminated by a special delimiter (CR – 0x0D). For each measurement message the following frame is transmitted:

M   t<sub>n</sub>   ,   i<sub>n</sub>   ,   V   v<sub>n</sub>   ,   D   d<sub>1</sub>   CR

Field	Shorthand	Length	Description
MeasurementStart	M	1	Start of measurement frame.
Type	t <sub>n</sub>	n	Hexadecimal value that identifies the type of measurement: 0x00 – Width (um) 0x01 – Height (um) 0x02 – Distance (um) 0x03 – Center X (um) 0x04 – Center Z (um) 0x05 – Position X (um) 0x06 – Position Z (um) 0x10 – Intersect X (um) 0x11 – Intersect Z (um) 0x12 – Intersect Angle (millidegrees) 0x13 – Angle X (millidegrees) 0x20 – Intersect Area (0.001 mm <sup>2</sup> ) 0x21 – Box Area (0.001 mm <sup>2</sup> ) 0x23 – Difference Area (0.001 mm <sup>2</sup> ) 0x24 – Difference Peak (um) 0x40 – Area (0.001 mm <sup>2</sup> ) 0x41 – Volume (0.001 mm <sup>3</sup> ) 0x42 – Part Height (um) 0x43 – Centroid X (um) 0x44 – Centroid Y (um) 0x45 – Centroid Z (um) 0x46 – Ellipse Major (um) 0x47 – Ellipse Minor (um) 0x48 – Ellipse Angle (millidegrees) 0x49 – Ellipse Ratio 0x4A – Bounding Box X (um) 0x4B – Bounding Box Y (um) 0x4C – Bounding Box Width (um) 0x4D – Bounding Box Length (um) 0x30 – Script (script-specific)
Id	i <sub>n</sub>	n	Hexadecimal value that represents the unique identifier of the measurement.
ValueStart	V	1	Start of measurement value. This field and the following Value field are optional – they will only be present if the measurement value has been selected for transmission.
Value	v <sub>n</sub>	n	Measurement value, in hexadecimal. The unit of the value is measurement-specific.
DecisionStart	D	1	Start of measurement decision. This field and the following Decision field are optional – they will only be present if the measurement decision has been selected for transmission.
Decision	d <sub>1</sub>	1	Measurement decision: 0 – Fail 1 – Pass
EndFrame	CR	1	Carriage return (0xD), marking end of frame.



Additional message types may be added in future releases. Each message type will begin with a unique letter. For future compatibility, software written to receive serial messages should ignore any messages not beginning with a recognized letter up to the trailing end of frame character (CR).

# Software Development Kit

The Gocator Software Development Kit (SDK) includes open-source software libraries and documentation that can be used to programmatically access and control Gocator sensors.

The latest version of the SDK can be downloaded from the downloads section, under the support tab, on the LMI Technologies website <http://www.lmi3d.com>.

The following components are included in the SDK.

Component	Description
Gocator API	Gocator API is a C language library that provides support for the commands and data formats used with Gocator sensors.
Gocator Console	Gocator Console is a small console-based application that demonstrates the use of Gocator API.

A pre-built DLL is provided to support 32-bit Windows XP (SP3+) and 32-bit Windows 7. Projects and makefiles are included to support other editions of Windows and Linux.

## Example: Configuring and starting a sensor with the Gocator API

```
#include <Go2.h>

void main()
{
    Go2System system = 0;

    //Open the Go2 library.
    Go2Api_Initialize();

    //Construct a Gocator 2000 system object.
    Go2System_Construct(&system);

    //Connect to default sensor IP address, with default password (blank).
    Go2System_Connect(system, GO2_DEFAULT_IP_ADDRESS, GO2_USER_ADMIN, "");

    //Reconfigure system to use time-based triggering.
    Go2System_SetTriggerSource(system, GO2_TRIGGER_SOURCE_TIME);

    //Send the system a "Start" command.
    Go2System_Start(system);

    //Free the system object.
    Go2System_Destroy(system);

    //Close the Go2 library.
    Go2Api_Terminate();
}
```

For more information about programming with the Gocator SDK, refer to the documentation and sample program included in the Gocator SDK.

# Troubleshooting

Review the guidance in this chapter if you are experiencing difficulty with a Gocator sensor system. If the problem that you are experiencing is not described in this chapter, please refer to Warranty and Return Policy (page 239) for further assistance.

## Mechanical/Environmental

### The sensor is warm.

- It is normal for a sensor to be warm when powered on. A Gocator sensor is typically 15° C warmer than the ambient temperature.

## Connection

### When attempting to connect to the sensor with a web browser, the sensor is not found (page does not load).

- Verify that the sensor is powered on and connected to the client computer network. The Power Indicator LED should illuminate when the sensor is powered.
- Check that the client computer's network settings are properly configured.
- Ensure that the latest version of Flash is loaded on the client computer.
- Use the LMI Discovery tool to verify that the sensor has the correct network settings. Refer to Recovery (page 150) for more information.

### When attempting to log in, the password is not accepted.

- Refer to Recovery (page 150) for steps to reset the password.

## Laser Profiling

### When the Start button or the Snapshot button is pressed, the sensor does not emit laser light.

- Ensure that the sticker covering the laser emitter window (normally affixed to new sensors) has been removed.
- The laser safety input signal may not be correctly applied. Refer to Specification (page 211) for more information.
- The exposure setting may be too low. Refer to Exposure (page 54) for more information on configuring exposure time.
- Use the Snapshot button instead of the Start button to capture a laser profile. If the laser flashes when you use the Snapshot button, but not when you use the Start button, then the problem could be related to triggering. Review the Trigger (page 48) for information on configuring the trigger source.

### The sensor emits laser light, but the Range Indicator LED does not illuminate and/or points are not displayed in the Data Viewer.

- Verify that the measurement target is within the sensor's field of view and measurement range. Refer to Specification (page 211) to review the measurement specifications for your sensor model.
- Check that the exposure time is set to a reasonable level. Refer to Exposure (page 54) for more information on configuring exposure time.

## Performance

### **The sensor CPU level is near 100%.**

- Consider reducing the speed. If you are using a time or encoder trigger source, refer to Trigger (page 48) for information on reducing the speed. If you are using an external input or software trigger, consider reducing the rate at which you apply triggers.
- Consider reducing the laser profile resolution. Refer to Resolutions (page 58) for more information on configuring laser profile resolution.
- Review the measurements that you have programmed and eliminate any unnecessary measurements.

# Specification

## Gocator sensors

The Gocator Family consists of the sensor models defined below.

### *Sensor Series Models*

	<b>2020</b>	<b>2030</b>	<b>2040</b>	<b>2050</b>	<b>2070</b>	<b>2080</b>
Frame Rate	Approx. 300 Hz – 5000 Hz					
Z Resolution (mm)	0.003 – 0.011	0.008 – 0.018	0.017 – 0.049	0.025 – 0.092	0.07 – 0.23	0.094 – 0.55
X Resolution (mm)	0.03 – 0.04	0.088 – 0.15	0.19 – 0.34	0.30 – 0.60	0.55 – 1.1	0.75 – 2.2
Clearance Distance (mm)	40	90	190	300	400	350
Measurement Range (mm)	25	80	210	400	500	800
Field of View (mm)	19 – 26	47 – 85	96 – 194	158 – 365	308 – 687	390 – 1260
Interface	100 Mbaud Ethernet					
Inputs	Differential Encoder, Laser Safety Enable, Trigger					
Outputs	2x Digital Output, RS-485 Serial (115 kBaud), 1x Analog Output (4 - 20 mA)					
Input Power	+24 to 48 VDC (10 Watts); Ripple +/- 10%					
Standard Laser Class	2M	2M	3R	3R	3B	3B
Available Laser Classes	3R	3R, 3B	2M, 3B	2M, 3B	2M, 3R	2M, 3R
Size (mm)	65 x 82 x 142	65 x 75 x 142	65 x 75 x 197	65 x 75 x 272	65 x 75 x 272	65 x 75 x 272
Weight (kg)	1.00	1.00	1.15	1.45	1.45	1.45
Housing	Gasketed aluminum enclosure, IP 67					

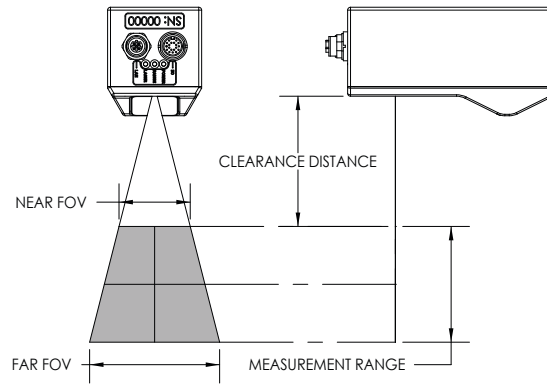

Mechanical dimensions for each sensor model are illustrated on the following pages.

Field of View / Measurement Range

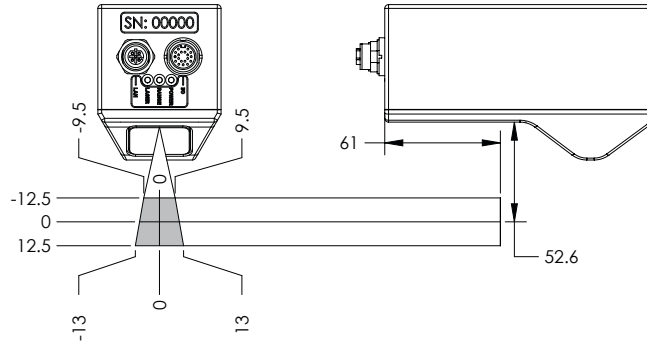

Dimensions

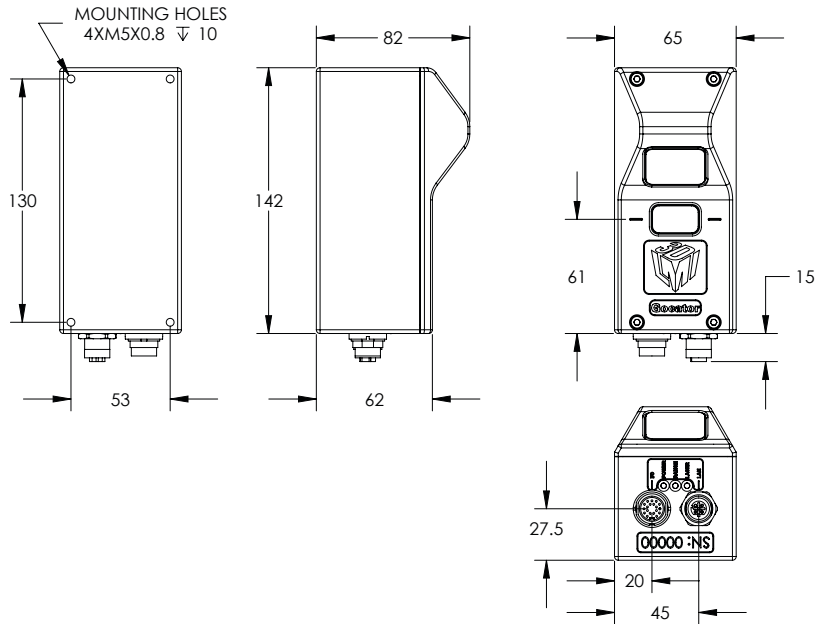

Envelope

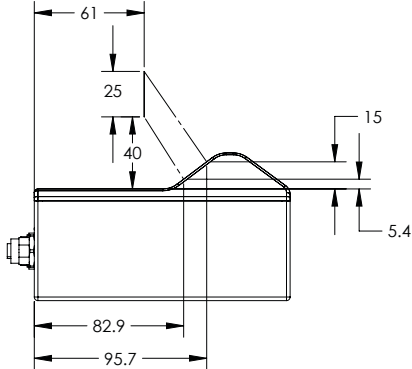

**Field of View / Measurement Range**

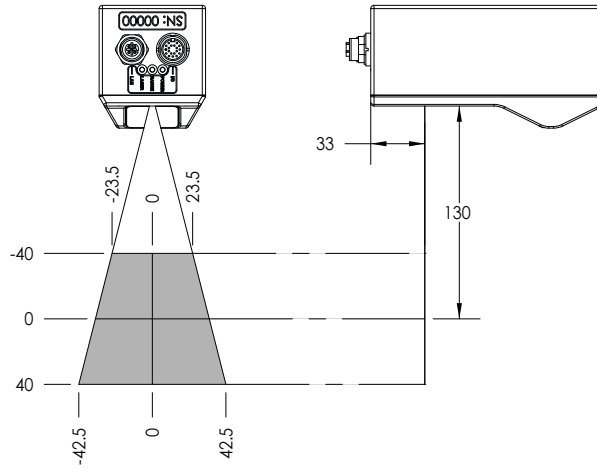

**Dimensions**

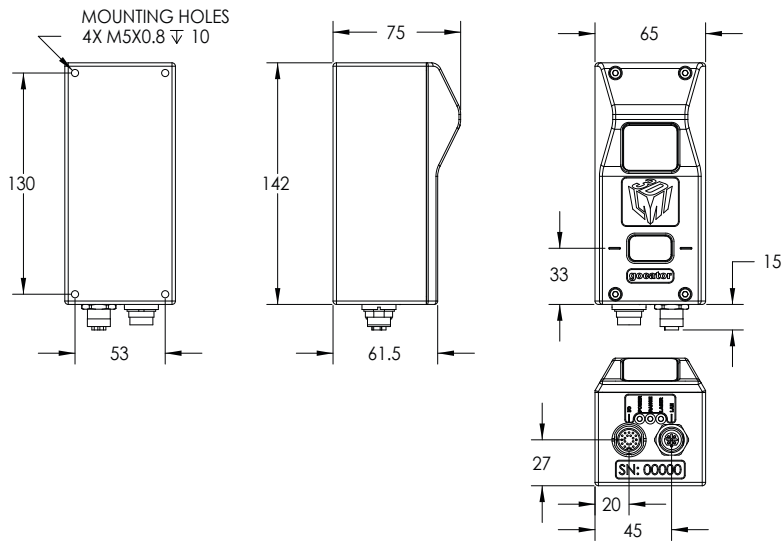

# Envelope

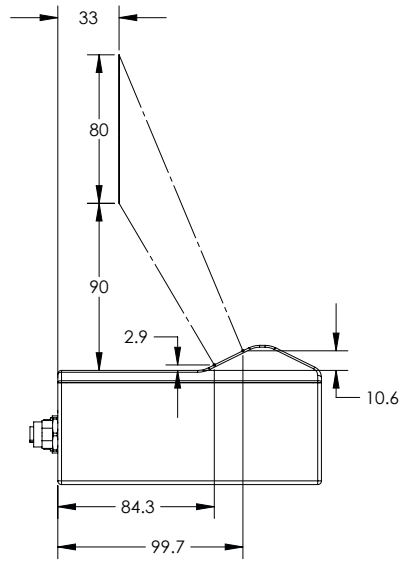

Field of View / Measurement Range

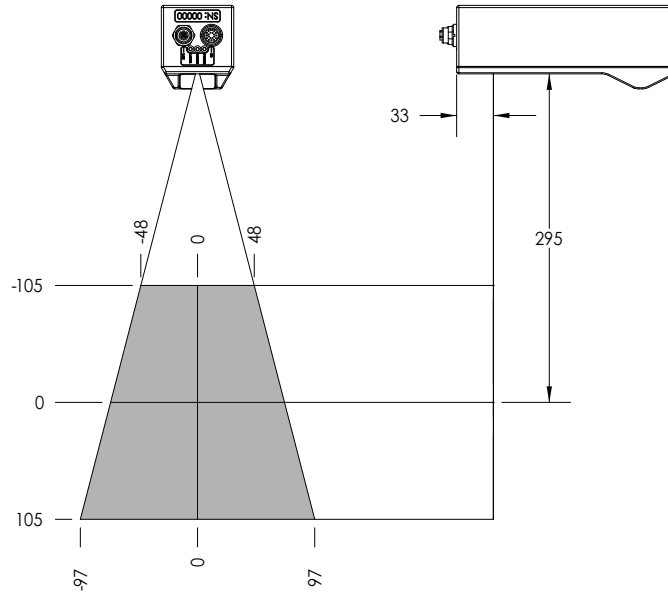

Dimensions

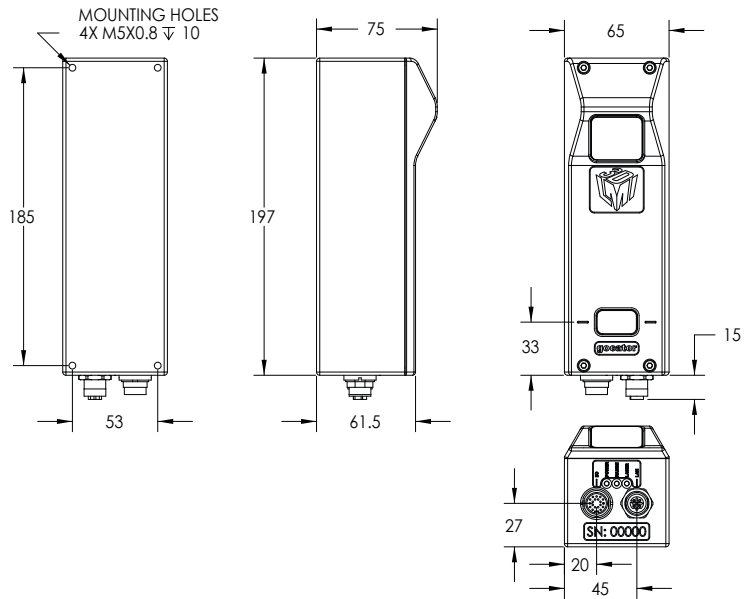

## Envelope

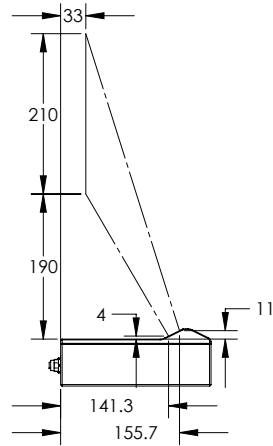

## Field of View / Measurement Range

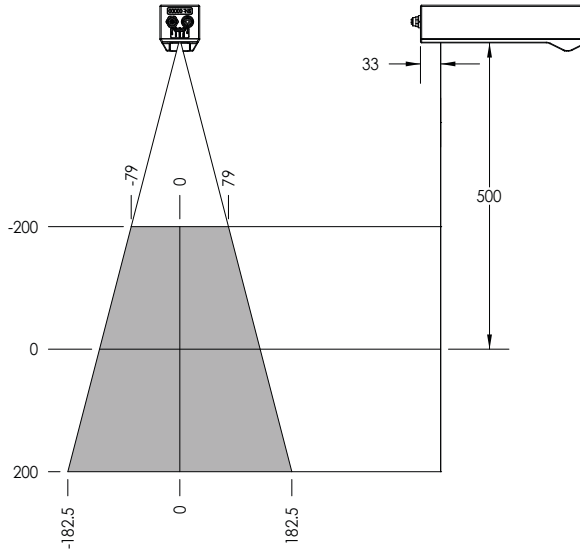

## Dimensions

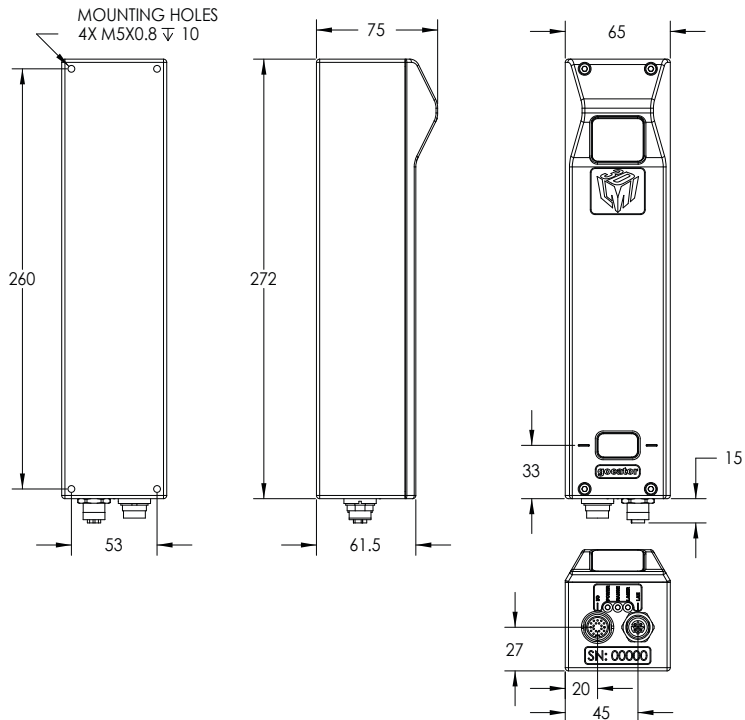

# Envelope

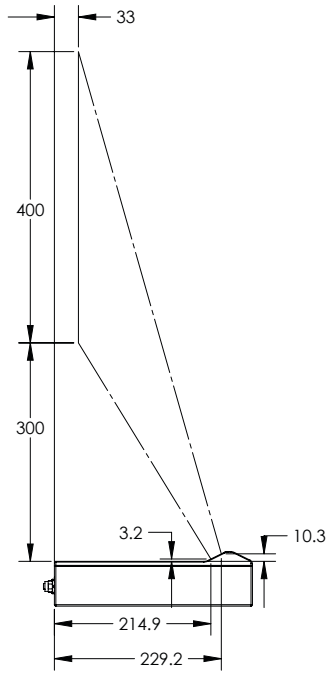

Field of View / Measurement Range

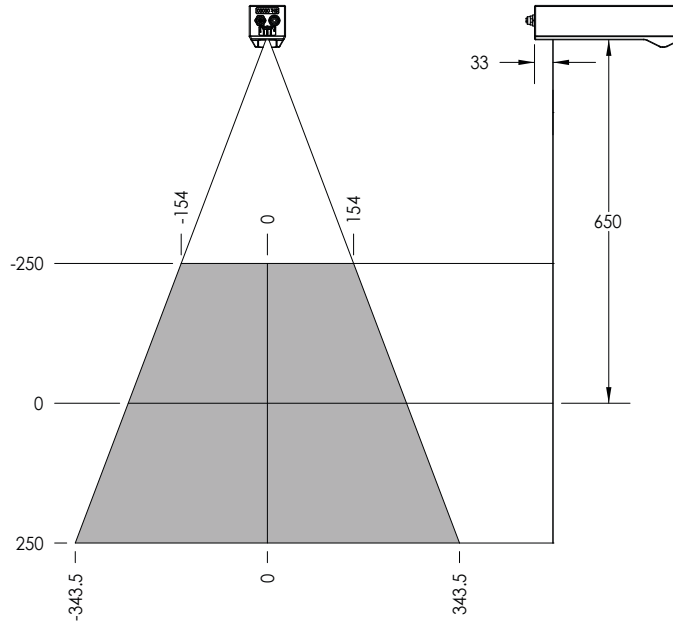

Dimensions

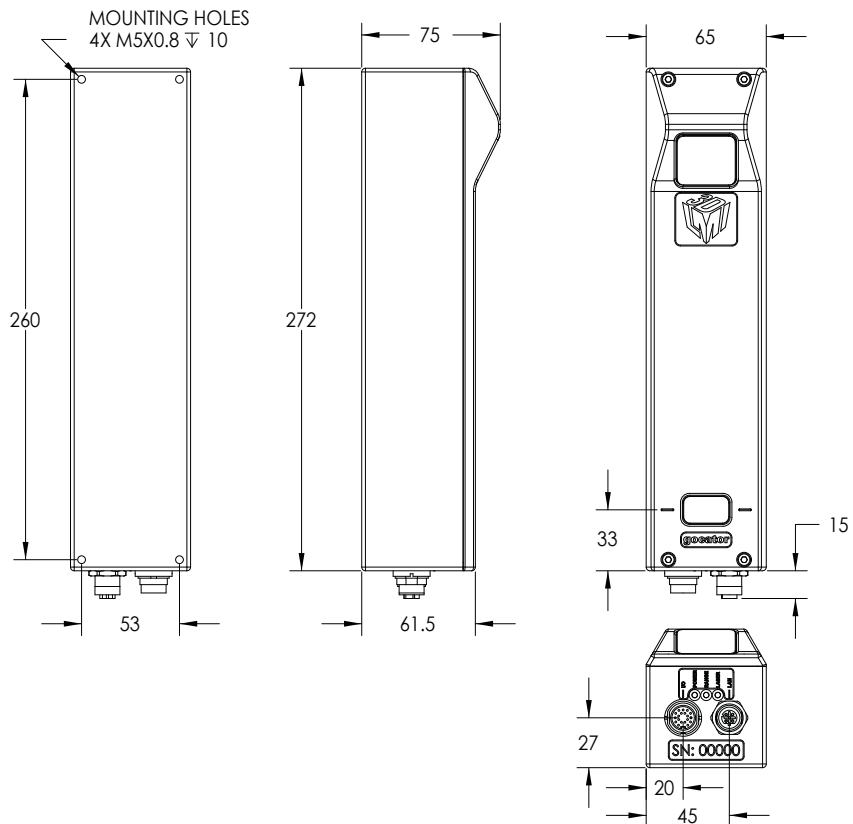

# Envelope

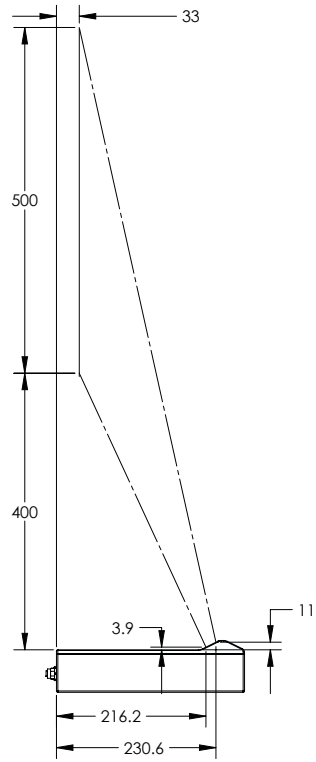

Field of View / Measurement Range

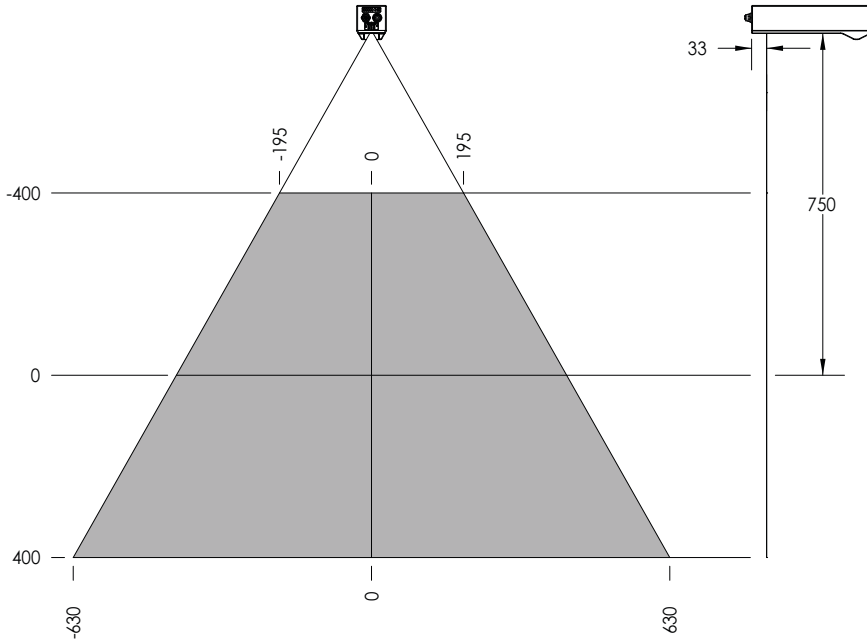

Dimensions

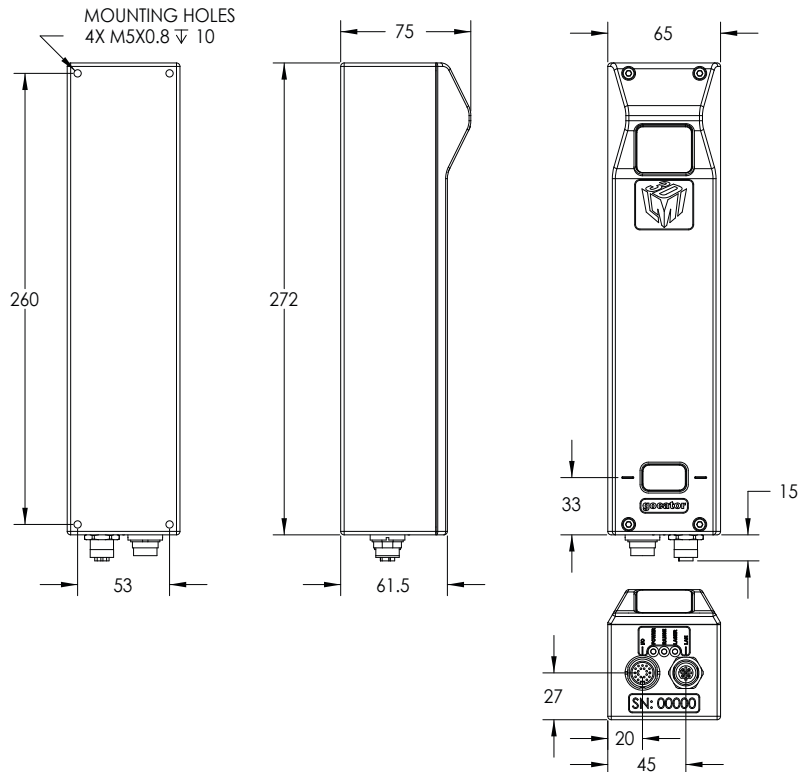

Envelope

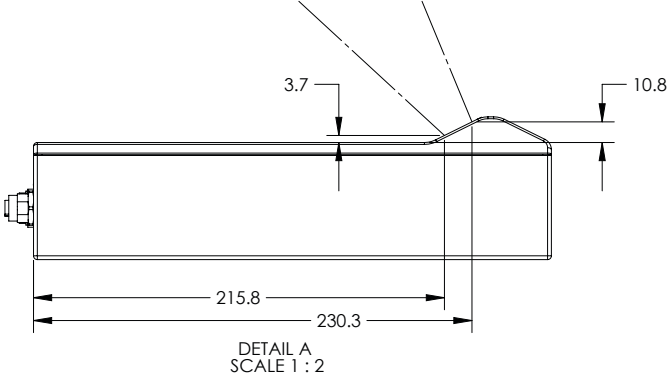
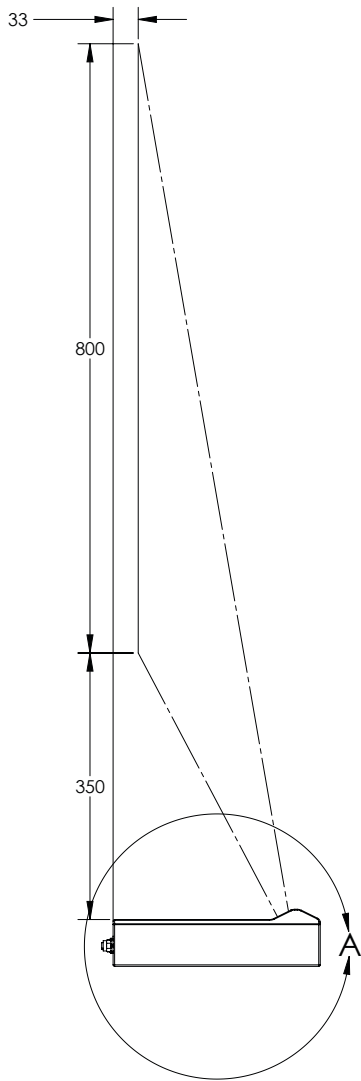

# Gocator I/O Connector

The Gocator I/O connector is a 19 pin, M16 style connector that provides power input, laser safety input, digital input, digital output, serial output, and analog output signals.

This section defines the electrical specifications for Gocator I/O Connector pins, organized by function.

## Gocator I/O Connector Pins

Function	Pins
DC_24-48V	A
Serial_out+	B
Serial_out-	C
Trigger_in+	D
Safety_in+	E
Analog_out-	F
Safety_in-	G
Trigger_in-	H
Encoder_B+	I
Encoder_B-	K
GND_0V	L
Encoder_A+	M
Out_1+ (Digital Output 0)	N
Out_1- (Digital Output 0)	O
Analog_out1+	P
Unused	R
Out_2+ (Digital Output 1)	S
Out_2- (Digital Output 1)	T
Encoder_A-	U

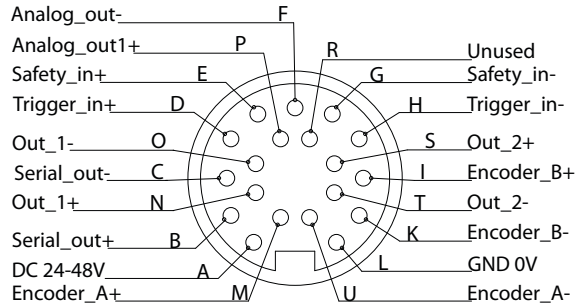

## Grounding Shield

The grounding shield should be mounted to the earth ground.

## Power

Positive voltage is applied to DC\_24-48V @ 10 Watts and Ground is applied to GND\_0VDC.

### Power requirements

Function	Pins	Min	Max
DC_24-48V	A	24 V	48 V
GND_0VDC	L	0 V	0 V

## Laser Safety Input

The Safety\_in+ signal should be connected to a voltage source in the range listed below. The Safety\_in- signal should be connected to the ground/common of the source supplying the Safety\_in+.

### *Laser safety requirements*

<b>Function</b>	<b>Pins</b>	<b>Min</b>	<b>Max</b>
Safety_in+	E	24 V	48 V
Safety_in-	G	0 V	0 V

## Digital Outputs

Each Gocator sensor has two optically-isolated outputs. Both outputs are open collector and open emitter, this allows a variety of power sources to be connected and a variety of signal configurations.

Out\_1 (Collector – Pin N and Emitter – Pin O) and Out\_2 (Collector – Pin S and Emitter Pin T) are independent and therefore V+ and GND are not required to be the same.

Function	Pins	Max Collector Current	Max Collector –Emitter Voltage	Min Pulse Width
Out_1	N,O	40 mA	70 V	20 us
Out_2	S,T	40 mA	70 V	20 us

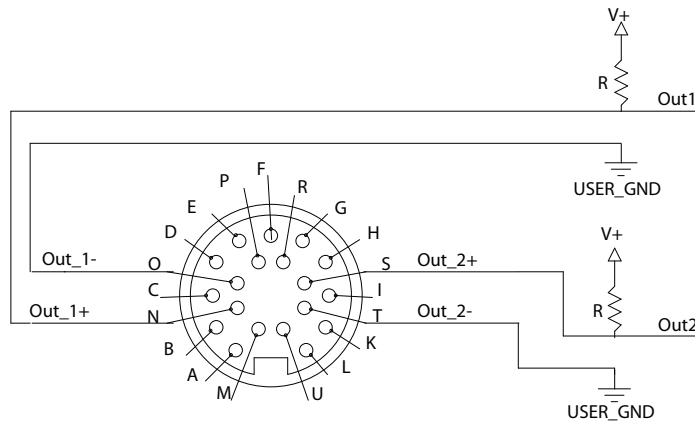

The resistors shown above are calculated by  $R = (V+) / 2.5\text{mA}$ .  
The size of the resistors is determined by power =  $(V+)^2 / R$ .

### Inverting Outputs

To invert an output, connect a resistor between ground and Out\_1- or Out\_2- and connect Out\_1+ or Out\_2+ to the supply voltage. Take the output at Out\_1- or Out\_2-. The resistor selection is the same as what is shown above.

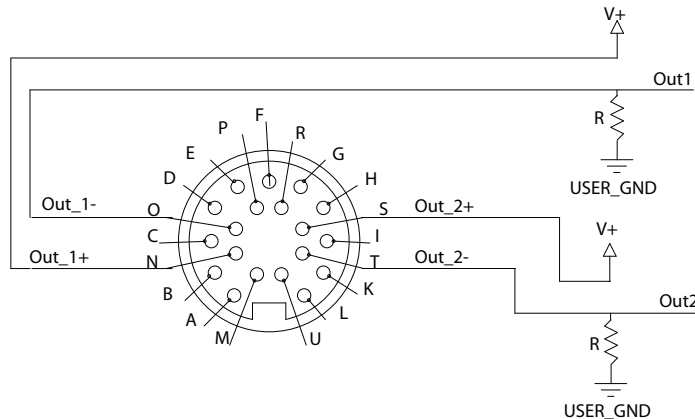

## Digital Inputs

Every Gocator sensor has a single optically-isolated input. To use this input, supply 2.5 - 12 V to Pin D and GND to Pin H.

### Active High

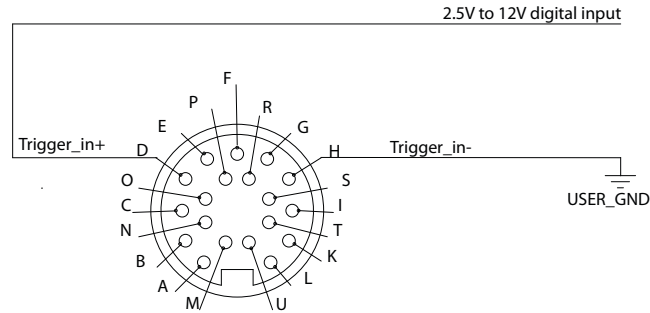

If the supplied voltage is greater than 12 V, connect an external resistor in series to Pin D. The resistor value should be  $R = [(V_{in} - 1.2V) / 10mA] - 330$ .

### Active Low

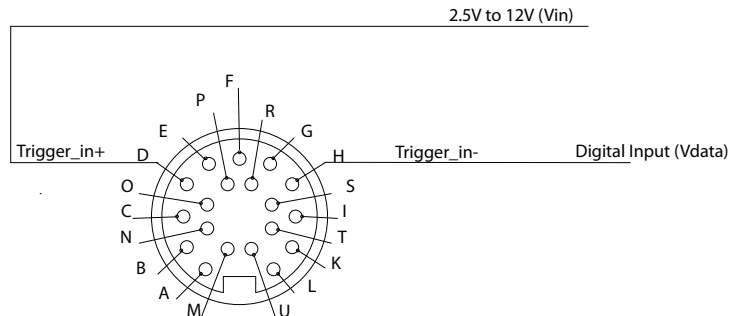

To assert the signal, the digital input voltage should be set to draw a current of 3 mA to 50mA from Trigger\_In+. The current that passes through Trigger\_In+ is  $I = (V_{in} - 1.2 - V_{data}) / 330$ . To reduce noise sensitivity, we recommend leaving a 20% margin for current variation (i.e. uses a digital input voltage that draws 4mA to 40mA).

Function	Pins	Min Voltage	Max Voltage	Min Current	Max Current	Min Pulse Width
Trigger_in	D	2.5 V	12 V	3 mA	50 mA	20 us

## Encoder Input

Encoder input is provided by an external encoder and consists of 2 RS-485 signals. These signals are connected to Encoder\_A and Encoder\_B.

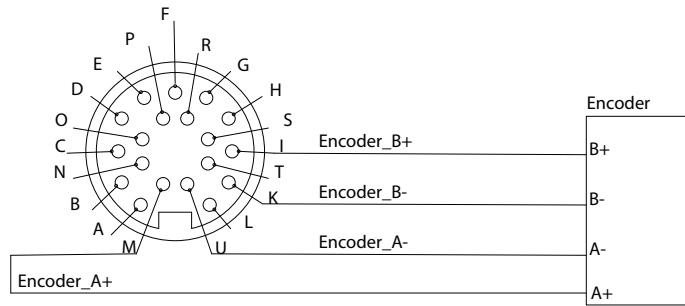

Function	Pins	Common Mode Voltage		Differential Threshold Voltage			Max Data Rate
		Min	Max	Min	Typ	Max	
Encoder_A	M, U	-7 V	12 V	-200 mV	-125 mV	-50 mV	1 MHz
Encoder_B	I, K	-7 V	12 V	-200 mV	-125 mV	-50 mV	1 MHz

 Gocator only supports differential RS485 signalling. Both + and - signals must be connected.

## Serial Output

Serial RS-485 output is connected to Serial\_out as shown below.

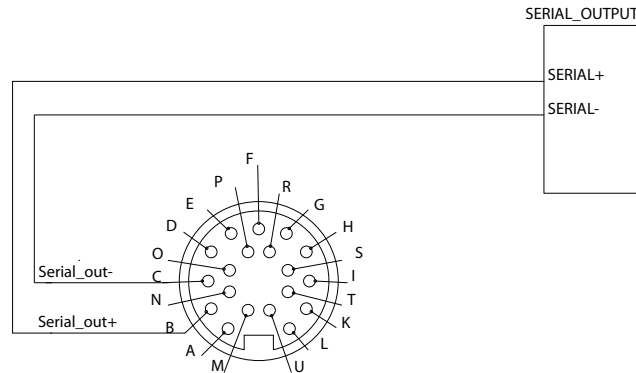

## Analog Output

The Sensor I/O Connector defines one analog output interfaces: Analog\_out1.

Function	Pins	Current Range
Analog_out1	P, F	4 – 20 mA

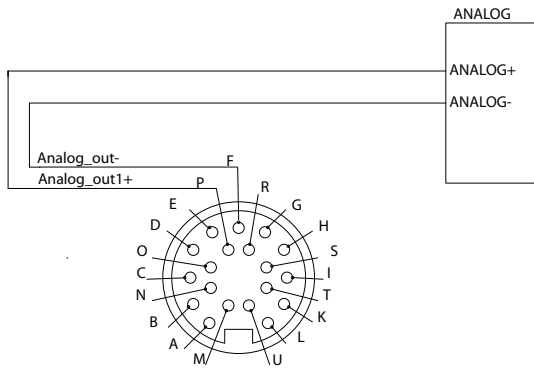

*Current Mode*

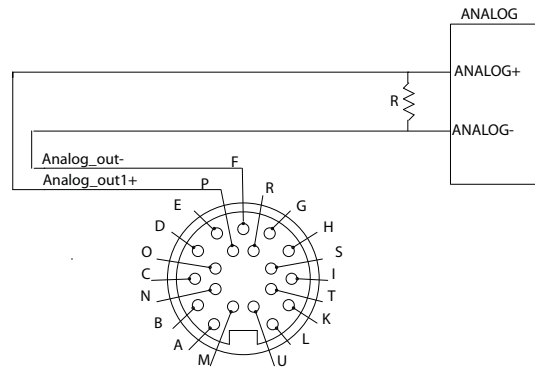

*Voltage Mode*

To configure for voltage output, connect a 500 Ohm ¼ Watt resistor between Analog\_out- and Analog\_out1+ and measure the voltage across the resistor.

# Master 200

The Master 200 accepts I/O connections for power, safety, encoder, serial output, analog output, digital input, and distributes these signals among 1 or 2 connected sensors.

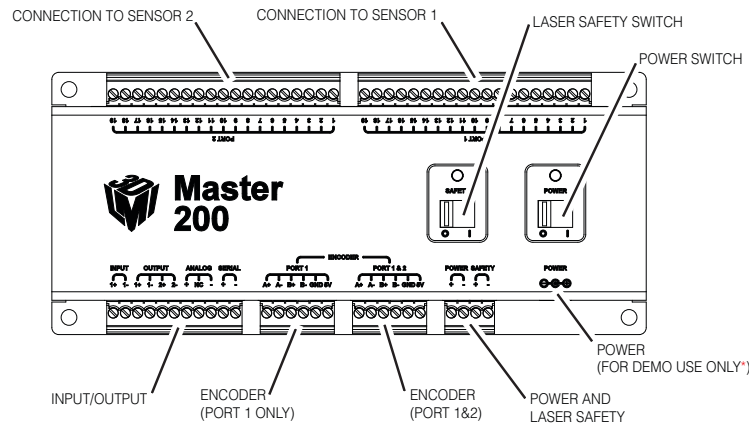

 \*Contact LMI for information regarding this type of power supply.

When using the Master 200 with a single sensor, connect the sensor to *Sensor Port 1* and connect the encoder to *Encoder (Port 1 Only)*. When using the Master 200 with two sensors, connect the sensors to *Sensor Port 1* and *Sensor Port 2*, and connect the encoder to *Encoder (Port 1&2)*.

Specifications for the Master 200 input, output, analog, serial, encoder, power (using a single sensor), and safety signals are identical to the specifications for the Gocator I/O Connector. Power required for 2 sensors is DC<sub>24</sub> - 48V @ 20 Watts.

*Sensor Port 1 and Port 2 Pins*

<b>Gocator I/O Pin</b>	<b>Master Pin</b>	<b>Conductor Color</b>
DC_24-48V	1	(White/Green &Black) and (Green/Black)
GND_0VDC	2	(White/Orange &Black) and (Orange/Black)
Safety_in+	3	Blue/Black
Safety_in-	4	White/Blue & Black
Trigger_in+	5	Grey
Trigger_in-	6	Pink
Out_1+	7	Red
Out_1-	8	Blue
Out_2+	9	Tan
Out_2-	10	Orange
Analog_out1+	11	Green
Unused	12	Maroon
Analog_out-	13	(Yellow) and (Maroon/White)
Encoder_A+	14	White/Brown & Black
Encoder_A-	15	Brown/Black
Serial_out+	16	White
Serial_out-	17	Brown
Encoder_B+	18	Black
Encoder_B-	19	Violet

*Input/Output Pins*

<b>Function</b>	<b>Pin</b>
Input+	1
Input-	2
Output_1+ (Digital Output 0)	3
Output_1- (Digital Output 0)	4
Output_2+ (Digital Output 1)	5
Output_2- (Digital Output 1)	6
Analog+	7
Unused	8
Analog-	9
Serial+	10
Serial-	11

*Encoder (Port 1 Only) Pins*

<b>Function</b>	<b>Pin</b>
Encoder_A+	1
Encoder_A-	2
Encoder_B+	3
Encoder_B-	4
Encoder_0V	5
Encoder_5V	6

*Power and Safety Pins*

<b>Function</b>	<b>Pin</b>
DC_+24 to +48V	1
GND_0VDC	2
Safety+	3
Safety-	4

*Encoder (Port 1&2) Pins*

<b>Function</b>	<b>Pin</b>
Encoder_A+	1
Encoder_A-	2
Encoder_B+	3
Encoder_B-	4
Encoder_0V	5
Encoder_5V	6

# Master 400/800

The Master 400/800 provides sensor power, safety interlock and broadcasts system-wide synchronization information (ie. time, encoder count, encoder index and digital I/O states) to all devices on a sensor network.



## Power and Safety (6 pin connector)

Function	Pin
+48VDC	1
+48VDC	2
GND(48VDC)	3
GND(48VDC)	4
Safety Control+	5
Safety Control-	6

The +48VDC power supply must be isolated from AC ground. This means that AC ground and DC ground are not connected.

The Safety Control requires a voltage differential 12VDC to 48VDC across the pin to enable the laser.

## Encoder (8 pin connector)

Function	Pin
Encoder_A+	1
Encoder_A-	2
Encoder_B+	3
Encoder_B-	4
Encoder_Z+	5
Encoder_Z-	6
GND	7
+5VDC	8

## Digital Input (16 pin connector)

Function	Pin
Input 1	1
Input 1 GND	2
Reserved	3
Reserved	4
Reserved	5
Reserved	6
Reserved	7
Reserved	8
Reserved	9
Reserved	10
Reserved	11
Reserved	12
Reserved	13
Reserved	14
Reserved	15
Reserved	16

This connector does not need to be wired up for proper operation.

## Master 400/800 Electrical Specifications

Electrical specifications for Master 400/800:

	Master 400	800
Power Supply Voltage		+48VDC
Power Supply current (Max.)		10A
Power Draw (Min.)		15W
Safety Voltage		+12 to +48VDC
Encoder signal voltage range		RS485 Differential
Digital input voltage range		Logical LOW: 0 VDC to +0.1VDC Logical HIGH: +11 VDC to +22.5VDC



When using a Master 400/800 it is crucial that its chassis be well grounded.



The +48VDC power supply must be isolated from AC ground. This means that AC ground and DC ground are not connected.



The Power Draw specification is based on a Master with no sensors attached. Every sensor has its own power requirements which need to be considered when calculating total system power requirements.

# Master 1200/2400

The Master 1200/2400 provides sensor power, safety interlock and broadcasts system-wide synchronization information (i.e. time, encoder count, encoder index, and digital I/O states) to all devices on a sensor network.

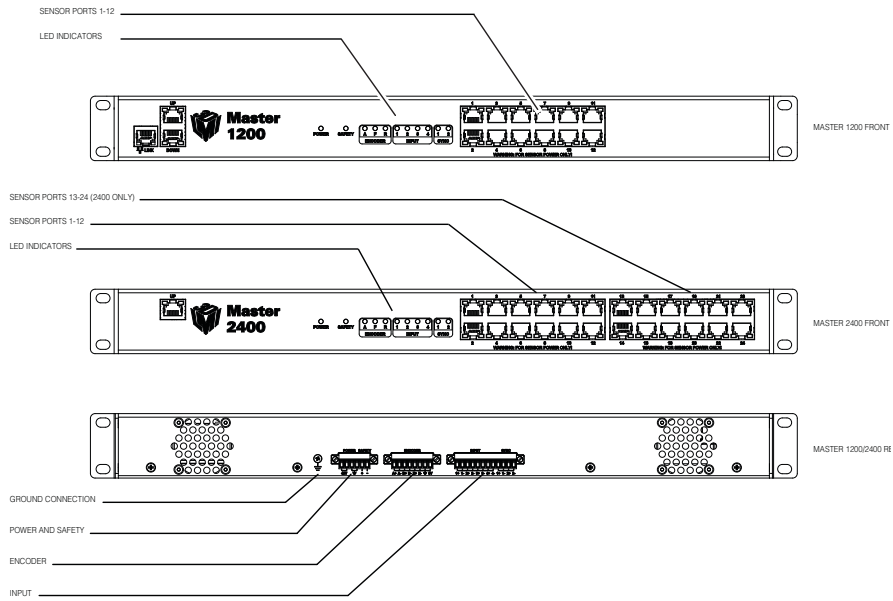

*Power and Safety (6 pin connector)*

Function	Pin
+48VDC	1
+48VDC	2
GND(48VDC)	3
GND(48VDC)	4
Safety Control+	5
Safety Control-	6

 The +48VDC power supply must be isolated from AC ground. This means that AC ground and DC ground are not connected.

 The Safety Control requires a voltage differential 12VDC to 48VDC across the pin to enable the laser.

*Encoder (8 pin connector)*

Function	Pin
Encoder_A+	1
Encoder_A-	2
Encoder_B+	3
Encoder_B-	4
Encoder_Z+	5
Encoder_Z-	6
GND	7
+5VDC	8

*Digital Input (16 pin connector)*

Function	Pin
Input 1	1
Input 1 GND	2
Reserved	3
Reserved	4
Reserved	5
Reserved	6
Reserved	7
Reserved	8
Reserved	9
Reserved	10
Reserved	11
Reserved	12

 This connector does not need to be wired up for proper operation.

## Master 1200/2400 Electrical Specifications

*Electrical specifications for Master 1200/2400:*

	Master 1200	2400
Power Supply Voltage	+48VDC	
Power Supply current (Max.)	10A	
Power Draw (Min.)	15W	
Safety Voltage	+12 to +48VDC	
Encoder signal voltage range	RS485 Differential	
Digital input voltage range	Logical LOW: 0 VDC to +0.1VDC Logical HIGH: +3.5 VDC to +6.5VDC	

 When using a Master 1200/2400 it is crucial that its chassis be well grounded.

 The +48VDC power supply must be isolated from AC ground. This means that AC ground and DC ground are not connected.

 The Power Draw specification is based on a Master with no sensors attached. Every sensor has its own power requirements which need to be considered when calculating total system power requirements.

# Parts and Accessories

## Gocator Part Number Legend

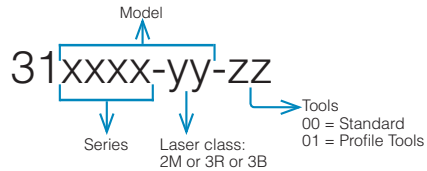

### Sensors (Model)

Description	Part Number
Gocator 2020 with Class 2M laser (2020-2M)	312020-2M-00
with Class 3R laser (2020-3R)	312020-3R-00
Gocator 2030 with Class 2M laser (2030-2M)	312030-2M-00
with Class 3R laser (2030-3R)	312030-3R-00
with Class 3B laser (2030-3B)	312030-3B-00
Gocator 2040 with Class 2M laser (2040-2M)	312040-2M-00
with Class 3R laser (2040-3R)	312040-3R-00
with Class 3B laser (2040-3B)	312040-3B-00
Gocator 2050 with Class 2M laser (2050-2M)	312050-2M-00
with Class 3R laser (2050-3R)	312050-3R-00
with Class 3B laser (2050-3B)	312050-3B-00
Gocator 2070 with Class 2M laser (2070-2M)	312070-2M-00
with Class 3R laser (2070-3R)	312070-3R-00
with Class 3B laser (2070-3B)	312070-3B-00
Gocator 2080 with Class 2M laser (2080-2M)	312080-2M-00
with Class 3R laser (2080-3R)	312080-3R-00
with Class 3B laser (2080-3B)	312080-3B-00
Standard tools	31XXXX-YY-00
Profile tools	31XXXX-YY-01

### Masters

Description	Part Number
Master 200 - for networking up to 2 sensors	30704
Master 400 - for networking up to 4 sensors	30680
Master 800 - for networking up to 8 sensors	30681
Master 1200 - for networking up to 12 sensors	30649
Master 2400 - for networking up to 24 sensors	30650

### Cordsets

Description	Part Number
5m Gocator Power/IO cordset	30737
10m Gocator Power/IO cordset	30738
5m Gocator Ethernet cordset	30741
10m Gocator Ethernet cordset	30742
5m Gocator Master cordset	30739
10m Gocator Master cordset	30740

*Accessories*

<b>Description</b>	<b>Part Number</b>
Calibration Disk, 40mm	30727
Calibration Disk, 100mm	30728
Calibration Disk, 250mm	30729
Calibration Disk, 375mm	30730

# Warranty and Return Policy

## Warranty Policy

The sensor is warranted for one year from the date of purchase from LMI Technologies Inc. Products that are found to be non-conforming during their warranty period are to be returned to LMI Technologies Inc.

The shipper is responsible for covering all duties and freight for returning the sensor to LMI. It is at LMI's discretion to repair or replace sensors that are returned for warranty work. LMI Technologies Inc. warranty covers parts, labor and return shipping charges.

If the warranty stickers on the sensors are removed or appear to be tampered with, LMI will void the warranty of the sensor.

## Return Policy

Before returning the product for repair (warranty or non-warranty) a Return Material Authorization (RMA) number must be obtained from LMI. Please call LMI to obtain this RMA number.

Carefully package the sensor in its original shipping materials (or equivalent) and ship the sensor prepaid to your designated LMI location. Please ensure that the RMA number is clearly written on the outside of the package. Inside the return shipment, include the address you wish the shipment returned to, the name, email and telephone number of a technical contact (should we need to discuss this repair), and details of the nature of the malfunction. For non-warranty repairs, a purchase order for the repair charges must accompany the returning sensor.

LMI Technologies Inc. is not responsible for damages to a sensor that are the result of improper packaging or damage during transit by the courier.

# Software Licenses

## **Pico-C**

Website:

<http://code.google.com/p/picoc/>

## **License:**

picoc is published under the "New BSD License".

<http://www.opensource.org/licenses/bsd-license.php>

*Copyright (c) 2009-2011, Zik Saleeba  
All rights reserved.*

Redistribution and use in source and binary forms, with or without modification, are permitted provided that the following conditions are met:

- \* Redistributions of source code must retain the above copyright notice, this list of conditions and the following disclaimer.
- \* Redistributions in binary form must reproduce the above copyright notice, this list of conditions and the following disclaimer in the documentation and/or other materials provided with the distribution.
- \* Neither the name of the Zik Saleeba nor the names of its contributors may be used to endorse or promote products derived from this software without specific prior written permission.

THIS SOFTWARE IS PROVIDED BY THE COPYRIGHT HOLDERS AND CONTRIBUTORS "AS IS" AND ANY EXPRESS OR IMPLIED WARRANTIES, INCLUDING, BUT NOT LIMITED TO, THE IMPLIED WARRANTIES OF MERCHANTABILITY AND FITNESS FOR A PARTICULAR PURPOSE ARE DISCLAIMED. IN NO EVENT SHALL THE COPYRIGHT OWNER OR CONTRIBUTORS BE LIABLE FOR ANY DIRECT, INDIRECT, INCIDENTAL, SPECIAL, EXEMPLARY, OR CONSEQUENTIAL DAMAGES (INCLUDING, BUT NOT LIMITED TO, PROCUREMENT OF SUBSTITUTE GOODS OR SERVICES; LOSS OF USE, DATA, OR PROFITS; OR BUSINESS INTERRUPTION) HOWEVER CAUSED AND ON ANY THEORY OF LIABILITY, WHETHER IN CONTRACT, STRICT LIABILITY, OR TORT (INCLUDING NEGLIGENCE OR OTHERWISE) ARISING IN ANY WAY OUT OF THE USE OF THIS SOFTWARE, EVEN IF ADVISED OF THE POSSIBILITY OF SUCH DAMAGE.

## **BlowFish**

Website:

<http://www.chiark.greenend.org.uk/~sgtatham/putty/licence.html>

## **License:**

*PuTTY is copyright 1997-2011 Simon Tatham.*

Portions copyright Robert de Bath, Joris van Rantwijk, Delian Delchev, Andreas Schultz, Jeroen Massar, Wez Furlong, Nicolas Barry, Justin Bradford, Ben Harris, Malcolm Smith, Ahmad Khalifa, Markus Kuhn, Colin Watson, and CORE SDI S.A.

Permission is hereby granted, free of charge, to any person obtaining a copy of this software and associated documentation files (the "Software"), to deal in the Software without restriction, including without limitation the rights to use, copy, modify, merge, publish, distribute, sublicense, and/or sell copies of the Software, and to permit persons to whom the Software is furnished to do so, subject to the following conditions:

The above copyright notice and this permission notice shall be included in all copies or substantial portions of the Software.

THE SOFTWARE IS PROVIDED "AS IS", WITHOUT WARRANTY OF ANY KIND, EXPRESS OR IMPLIED, INCLUDING BUT NOT LIMITED TO THE WARRANTIES OF MERCHANTABILITY, FITNESS FOR A PARTICULAR PURPOSE AND NONINFRINGEMENT. IN NO EVENT SHALL SIMON TATHAM BE LIABLE FOR ANY CLAIM, DAMAGES OR OTHER LIABILITY, WHETHER IN AN ACTION OF CONTRACT, TORT OR OTHERWISE, ARISING FROM, OUT OF OR IN CONNECTION WITH THE SOFTWARE OR THE USE OR OTHER DEALINGS IN THE SOFTWARE.

### **CodeMirror**

Website:

<http://codemirror.net>

### **License:**

*Copyright (C) 2011 by Marijn Haverbeke <[marijnh@gmail.com](mailto:marijnh@gmail.com)>*

Permission is hereby granted, free of charge, to any person obtaining a copy of this software and associated documentation files (the "Software"), to deal in the Software without restriction, including without limitation the rights to use, copy, modify, merge, publish, distribute, sublicense, and/or sell copies of the Software, and to permit persons to whom the Software is furnished to do so, subject to the following conditions:

The above copyright notice and this permission notice shall be included in all copies or substantial portions of the Software.

THE SOFTWARE IS PROVIDED "AS IS", WITHOUT WARRANTY OF ANY KIND, EXPRESS OR IMPLIED, INCLUDING BUT NOT LIMITED TO THE WARRANTIES OF MERCHANTABILITY, FITNESS FOR A PARTICULAR PURPOSE AND NONINFRINGEMENT. IN NO EVENT SHALL THE AUTHORS OR COPYRIGHT HOLDERS BE LIABLE FOR ANY CLAIM, DAMAGES OR OTHER LIABILITY, WHETHER IN AN ACTION OF CONTRACT, TORT OR OTHERWISE, ARISING FROM, OUT OF OR IN CONNECTION WITH THE SOFTWARE OR THE USE OR OTHER DEALINGS IN THE SOFTWARE.

### **jQuery**

Website:

<http://jquery.com/>

### **License:**

*Copyright (c) 2011 John Resig, <http://jquery.com/>*

Permission is hereby granted, free of charge, to any person obtaining a copy of this software and associated documentation files (the "Software"), to deal in the Software without restriction, including without limitation the rights to use, copy, modify, merge, publish, distribute, sublicense, and/or sell copies of the Software, and to permit persons to whom the Software is furnished to do so, subject to the following conditions:

The above copyright notice and this permission notice shall be included in all copies or substantial portions of the Software.

THE SOFTWARE IS PROVIDED "AS IS", WITHOUT WARRANTY OF ANY KIND, EXPRESS OR IMPLIED, INCLUDING BUT NOT LIMITED TO THE WARRANTIES OF MERCHANTABILITY, FITNESS FOR A PARTICULAR PURPOSE AND NONINFRINGEMENT. IN NO EVENT SHALL THE AUTHORS OR COPYRIGHT HOLDERS BE LIABLE FOR ANY CLAIM, DAMAGES OR OTHER LIABILITY, WHETHER IN AN ACTION OF CONTRACT, TORT OR OTHERWISE, ARISING FROM, OUT OF OR IN CONNECTION WITH THE SOFTWARE OR THE USE OR OTHER DEALINGS IN THE SOFTWARE.

### **Closure Library**

Website:

<http://code.google.com/closure/library/index.html>

### **License:**

*Copyright 2006 The Closure Library Authors. All Rights Reserved.*

Licensed under the Apache License, Version 2.0 (the "License"); you may not use this file except in compliance with the License.

You may obtain a copy of the License at <http://www.apache.org/licenses/LICENSE-2.0>

Unless required by applicable law or agreed to in writing, software distributed under the License is distributed on an "AS-IS" BASIS, WITHOUT WARRANTIES OR CONDITIONS OF ANY KIND, either express or implied. See the License for the specific language governing permissions and limitations under the License.

### **jQuery.CopyEvents**

Website:

<http://brandonaaron.net>

### **License:**

*Copyright (c) 2006 Brandon Aaron*

Licensed under the MIT License (<http://www.opensource.org/licenses/mit-license.php>)

### **jQuery.history**

#### **License:**

jQuery history plugin

*Copyright (c) 2006 Taku Sano (Mikage Sawatari)*

Licensed under the MIT License (<http://www.opensource.org/licenses/mit-license.php>)

Modified by Lincoln Cooper to add Safari support and only call the callback once during initialization for msie when no initial hash supplied. API rewrite by Lauris Bukis-Haberkorns

### **jQuery.mouseWheel**

Website:

<http://brandonaaron.net>

### **License:**

*Copyright (c) 2010 Brandon Aaron*

Licensed under the MIT License (<http://www.opensource.org/licenses/mit-license.php>)

### **jQuery.scaling**

Website:

<http://eric.garside.name>

#### **License:**

Scaling 1.0 - Scale any page element

*Copyright (c) 2009 Eric Garside*

Licensed under the MIT License (<http://www.opensource.org/licenses/mit-license.php>)

### **jQuery.scrollFollow**

Website:

<http://kitchen.net-perspective.com/>

#### **License:**

*Copyright (c) 2008 Net Perspective*

Licensed under the MIT License (<http://www.opensource.org/licenses/mit-license.php>)

### **Flex SDK**

Website:

<http://opensource.adobe.com/wiki/display/flexsdk/Flex+SDK>

#### **License:**

*Copyright (c) 2010 Adobe Systems Incorporated*

The contents of this file are subject to the Mozilla Public License Version 1.1 (the "License"); you may not use this file except in compliance with the License. You may obtain a copy of the License at <http://www.mozilla.org/MPL/>

Software distributed under the License is distributed on an "AS IS" basis, WITHOUT WARRANTY OF ANY KIND, either express or implied. See the License for the specific language governing rights and limitations under the License.

# Support

For assistance regarding a component or product, please contact LMI Technologies.

## World

---

Email [support@lmi3d.com](mailto:support@lmi3d.com)

---

Web <http://www.lmi3d.com>

## North America

---

Phone +1 604 636 1011

---

Fax +1 604 516 8368

## Europe

---

Phone +31 45 850 7000

---

Fax +31 45 574 2500

For more information on safety and laser classifications, please contact:

*U.S. Food and Drug Administration  
Center for Devices and Radiological Health  
WO66-G609  
10903 New Hampshire Avenue  
Silver Spring, MD 20993-0002  
USA*



**North America**

LMI Technologies Inc.  
1673 Cliveden Avenue  
Delta BC V3M 6V5  
Canada  
Phone: +1 604 636 1011  
Fax: +1 604 516 8368

**Europe**

LMI Technologies BV  
Valkenburgerweg 223  
NL-6419AT Heerlen  
The Netherlands  
Phone: +31 45 850 7000  
Fax: +31 45 574 2500